

# 430 GSR2 Insert (with screen)

## Owner's Manual



**TRAVIS INDUSTRIES  
HOUSE OF FIRE**

### **⚠ WARNING:**

If the information in these instructions is not followed exactly, a fire or explosion may result causing property damage, personal injury or loss of life.

- Do not store or use gasoline or other flammable vapors and liquids in the vicinity of this or any other appliance.
- **WHAT TO DO IF YOU SMELL GAS**
  - Do not try to light any appliance.
  - Do not touch any electrical switch; do not use any phone in your building.
  - Immediately call your gas supplier from a neighbor's phone. Follow the gas supplier's instructions.
  - If you cannot reach your gas supplier, call the fire department.
- Installation and service must be performed by a qualified installer, service agency or the gas supplier.



**HOT GLASS WILL CAUSE  
BURNS**

**DO NOT TOUCH GLASS  
UNTIL COOLED**

**NEVER ALLOW CHILDREN  
TO TOUCH GLASS**

**A barrier designed to reduce the risk of burns from the hot viewing glass is provided with this appliance and shall be installed for the protection of children and other at-risk individuals.**

Tested and Listed by



**Intertek**

ANSI Z21.88-2014  
CSA 2.33-2014

- **Direct Vent Fireplace Insert**
- **Masonry or Factory-Built (Metal) Wood-Burning Fireplace**
- **Residential or Mobile Home**

**This appliance may be installed in an aftermarket, permanently located, manufactured home (USA only) or mobile home, where not prohibited by local codes.**

**This appliance is only for use with the type of gas indicated on the rating plate. A conversion kit is supplied with the appliance.**

**INSTALLER: Leave this manual with the appliance.**

**CONSUMER: Retain this manual for future reference.**

## Introduction

We welcome you as a new owner of a 430 GSR2 Insert. In purchasing this fireplace insert you have joined the growing ranks of concerned individuals whose selection of an energy system reflects both a concern for the environment and aesthetics. It is one of the finest home heaters the world over. This manual will explain the installation, operation, and maintenance of this heater. Please familiarize yourself with the Owner's Manual before operating your heater and save the manual for future reference. Included are helpful hints and suggestions that will make the operation and maintenance of your new heater an easier and more enjoyable experience. We offer our continual support and guidance to help you achieve the maximum benefit and enjoyment from your heater.

## Important Information

No other 430 GSR2 Insert has the same serial number as yours. The serial number is below and to the left of the gas control valve.

This serial number will be needed in case you require service of any type.

Model: 430 GSR2

Serial Number: \_\_\_\_\_

Purchase Date: \_\_\_\_\_

Purchased From: \_\_\_\_\_

\_\_\_\_\_

\_\_\_\_\_

**Register your warranty online at:**

[traviswarranty.com](http://traviswarranty.com)

**Or, mail your warranty card to:**

Travis Industries House of Fire  
12521 Harbour Reach Drive  
Mukilteo, WA 98275

**Save Your Bill of Sale.**

To receive full warranty coverage, you will need to show evidence of the date you purchased your heater. Do not mail your Bill of Sale to us.

We suggest that you attach your Bill of Sale to this page so that you will have all the information you need in one place should the need for service or information occur.

## Listing Details

This appliance was listed by Intertek. The listing label is attached to the appliance near the gas control valve. A copy is shown on page 44.

### Massachusetts Approval

This manual has been submitted to the Massachusetts Board of State Examiners of Plumbers and Gas Fitters.

### National Fireplace Institute



<b>Introduction</b> .....	<b>2</b>
<b>Important Information</b> .....	<b>2</b>
<b>Listing Details</b> .....	<b>2</b>
<b>Features</b> .....	<b>6</b>
<b>Installation Options</b> .....	<b>6</b>
<b>Heating Specifications</b> .....	<b>6</b>
<b>Dimensions</b> .....	<b>6</b>
<b>Electrical Specifications (for blowers)</b> .....	<b>6</b>
<b>Fuel</b> .....	<b>6</b>
<b>Installation Warnings</b> .....	<b>7</b>
<b>Packing List</b> .....	<b>7</b>
<b>Additional Items Required</b> .....	<b>7</b>
<b>Order of Installation</b> .....	<b>7</b>
<b>Fireplace Requirements</b> .....	<b>8</b>
Fireplace Clearances to Gas Insert.....	8
Factory-Built (Metal) Wood-Burning Fireplace Requirements.....	9
<b>Hearth Requirements</b> .....	<b>9</b>
<b>Leveling Bolts</b> .....	<b>10</b>
<b>Electrical Requirements</b> .....	<b>10</b>
<b>Clearances</b> .....	<b>11</b>
Mantel Clearances .....	11
<b>Gas Line Requirements</b> .....	<b>12</b>
Gas Inlet Pressure .....	12
Directions for Connecting a Gas Pressure Test Gauge .....	12
<b>Gas Line Installation</b> .....	<b>13</b>
<b>Vent Requirements</b> .....	<b>14</b>
Altitude Considerations.....	14
<b>Exhaust Restrictor</b> .....	<b>15</b>
Adjusting the Exhaust Restrictor .....	16
<b>Diffuser Adjustment</b> .....	<b>17</b>
Adjusting the Diffuser .....	17
<b>Vent Installation</b> .....	<b>18</b>
Vent Location .....	18
Vent Configurations .....	18
Vent Attachment – Tight Installations.....	19
Vent Connector Attachment.....	20
<b>Glass Frame Removal and Installation</b> .....	<b>23</b>
<b>Steps for Finalizing the Installation</b> .....	<b>24</b>
Air Shutter Adjustment .....	25
Burner Removal.....	26
<b>Before You Begin</b> .....	<b>29</b>
Remote Control Warnings .....	29

<b>Remote Set-Up</b> .....	<b>30</b>
Verify the Switch is on “REMOTE” .....	30
Synchronize the Transmitter to the IFC.....	30
Clearing the System Memory .....	30
<b>Starting the Heater for the First Time</b> .....	<b>31</b>
<b>Location of Controls</b> .....	<b>31</b>
<b>Direct Operation</b> .....	<b>31</b>
<b>Continuous/Intermittent Pilot Switch</b> .....	<b>32</b>
Switching from Intermittent (IPI) to Continuous Pilot (CPI).....	32
<b>Remote Operation</b> .....	<b>33</b>
Display Overview .....	33
Listen for the “Beep” .....	33
<b>Manual On-Off / Smart Thermostat / Standard Thermostat</b> .....	<b>34</b>
<b>Mode Controls (Flame, Blower, Light, Comfort Control)</b> .....	<b>35</b>
Flame Height.....	35
Blower Speed.....	35
<b>Mode Controls (continued)</b> .....	<b>36</b>
Accent Light .....	36
Comfort Control (rear burner).....	36
<b>Display Fahrenheit or Celsius</b> .....	<b>36</b>
<b>Low Battery Indicator</b> .....	<b>37</b>
Transmitter Batteries.....	37
IFC Batteries .....	37
<b>Battery Replacement</b> .....	<b>37</b>
Battery Installation .....	37
Transmitter Battery Installation .....	37
<b>Power Outages</b> .....	<b>37</b>
<b>Child-Proof Feature</b> .....	<b>38</b>
<b>Normal Operating Sounds</b> .....	<b>38</b>
<b>Normal Operating Odors</b> .....	<b>38</b>
<b>Maintaining Your Heater's Appearance</b> .....	<b>39</b>
<b>Accent Light Replacement</b> .....	<b>39</b>
Lower Accent Lights .....	39
Upper Accent Lights .....	39
<b>Yearly Service Procedure</b> .....	<b>41</b>
<b>Troubleshooting Table</b> .....	<b>42</b>
<b>Wiring Diagram</b> .....	<b>43</b>
<b>Replacement Parts</b> .....	<b>43</b>
Safety Label.....	44
<b>CONDITIONS &amp; EXCLUSIONS</b> .....	<b>45</b>
<b>IF WARRANTY SERVICE IS NEEDED:</b> .....	<b>45</b>
<b>LP Conversion Instructions</b> .....	<b>46</b>

- Failure to follow all of the requirements may result in property damage, bodily injury, or even death.

**Young children should be carefully supervised when they are in the same room as the appliance. Toddlers, young children and others may be susceptible to accidental contact burns. A physical barrier is recommended if there are at risk individuals in the house. To restrict access to a fireplace or stove, install an adjustable safety gate to keep toddlers, young children and other at risk individuals out of the room and away from hot surfaces.**

**Children and adults should be alerted to the hazards of high surface temperature and should stay away to avoid burns or clothing ignition. Do not touch the hot surfaces of the heater. Educate all children of the danger of a high-temperature heater.**

**Due to the high temperature, the heater should be located out of traffic and away from furniture and draperies.**

- This unit must be installed by a qualified installer to prevent the possibility of an explosion.
- This appliance must be installed in accordance with all local codes, if any; if not, in U.S.A. follow ANSI Z223.1 and NFPA 54(88), in Canada follow CSA B149.1.
- A manufactured home (USA only) or mobile home OEM installation must conform with the Manufactured Home Construction and Safety Standard, Title 24 CFR, Part 3280, or, when such a standard is not applicable, the Standard for Manufactured Home Installations, ANSI/NCSBCS A225.1, or Standard for Gas Equipped Recreational Vehicles and Mobile Housing, CSA Z240.4. This appliance may be installed in Manufactured Housing only after the home is site located.
- All exhaust gases must be vented outside the structure of the living-area. Combustion air is drawn from outside the living-area structure. The venting must not be connected to a chimney flue serving a separate solid-fuel burning appliance.
- Notify your insurance company before hooking up this fireplace.
- The instructions in this manual must be strictly adhered to. Do not use makeshift methods or compromise in the installation. Improper installation will void the warranty and safety listing.
- This heater is approved for use with natural gas (NG) or propane (LP). Burning the incorrect fuel will void the warranty and safety listing and may cause an extreme safety hazard. Direct questions about the type of fuel used to your dealer.
- Contact your local building officials to obtain a permit and information on any installation restrictions or inspection requirements in your area.
- If the flame becomes sooty, dark orange in color, or extremely tall, do not operate the heater. Call your dealer and arrange for proper servicing.
- It is imperative that control compartments, screens, or circulating air passageways of the heater be kept clean and free of obstructions. These areas provide the air necessary for safe operation.
- Do not operate the heater if it is not operating properly in any fashion or if you are uncertain. Call your dealer for a full explanation of your heater and what to expect.
- Do not store or use gasoline or other flammable liquids in the vicinity of this heater.
- Do not operate if any portion of the heater was submerged in water or if any corrosion occurs. Immediately call a qualified service technician to inspect the appliance and to replace any part of the control system and any gas control which has been under water.

***Safety Warnings (continued)***

---

- Because this heater can be controlled by a thermostat there is a possibility of the heater turning on and igniting any items placed on or near the appliance.
- Light the heater using the built-in igniter. Do not use matches or any other external device to light your heater.
- Never remove, replace, modify or substitute any part of the heater unless instructions are given in this manual. All other work must be done by a trained technician. Don't modify or replace orifices.
- The viewing glass should be opened only for conducting service.
- Allow the heater to cool before carrying out any maintenance or cleaning.
- Operate the heater according to the instructions included in this manual.
- If the main burners do not start correctly turn the gas off and call your dealer for service.
- This unit is not for use with solid fuel.
- Do not place anything inside the firebox (except the optional artwork).
- **Warning:** Do not operate appliance with the glass front removed, cracked or broken. Replacement of the glass should be done by a licensed or qualified service person.
- Do not throw this manual away. This manual has important operating and maintenance instructions that you will need at a later time. Always follow the instructions in this manual.
- Instruct everyone in the house how to shut gas off to the appliance and at the gas main shutoff valve. The gas main shutoff valve is usually next to the gas meter or propane tank and requires a wrench to shut off.
- A barrier designed to reduce the risk of burns from the hot viewing glass is provided with this appliance and shall be installed for the protection of children and other at-risk individuals.
- If the barrier becomes damaged, the barrier shall be replaced with the manufacturer's barrier for this appliance.
- Clothing or other flammable material should not be placed on or near the appliance.
- Any safety screen, guard, or barrier removed for servicing an appliance must be replaced prior to operating the appliance.
- Installation and repair should be done by a qualified service person. The appliance should be inspected before use and at least annually by a professional service person. More frequent cleaning might be required due to excessive lint from carpeting, bedding material, et cetera. It is imperative that control compartments, burners, and circulating air passageways of the appliance be kept clean.
- **Travis Industries, Inc. grants no warranty, implied or stated, for the installation or maintenance of your heater, and assumes no responsibility of any consequential damage(s).**

**Proposition 65 Warning:** Fuels used in gas, woodburning or oil fired appliances, and the products of combustion of such fuels, contain chemicals known to the State of California to cause cancer, birth defects and other reproductive harm.  
California Health & Safety Code Sec. 25249.6

**Features**

- Works During Power Outages (battery backup system)
- Blowers and Remote Control Included
- Continuous or Intermittent (GreenSmart) Pilot
- Convenient Operating Controls
- Variable-Rate Heat Output
- Accent Lights

**Installation Options**

- Residential or Mobile Home
- Fireplace Insert
- Existing Masonry or Factory Built (Metal) Wood-Burning Fireplace

**Heating Specifications**

Approximate Heating Capacity (in square feet)\*  
 Maximum BTU Input Per Hour

**Natural Gas**  
 500 to 1,600  
 31,000

**Propane**  
 500 to 1,600  
 31,000

\* Heating capacity will vary with floor plan, insulation, and outside temperature.

**Dimensions**

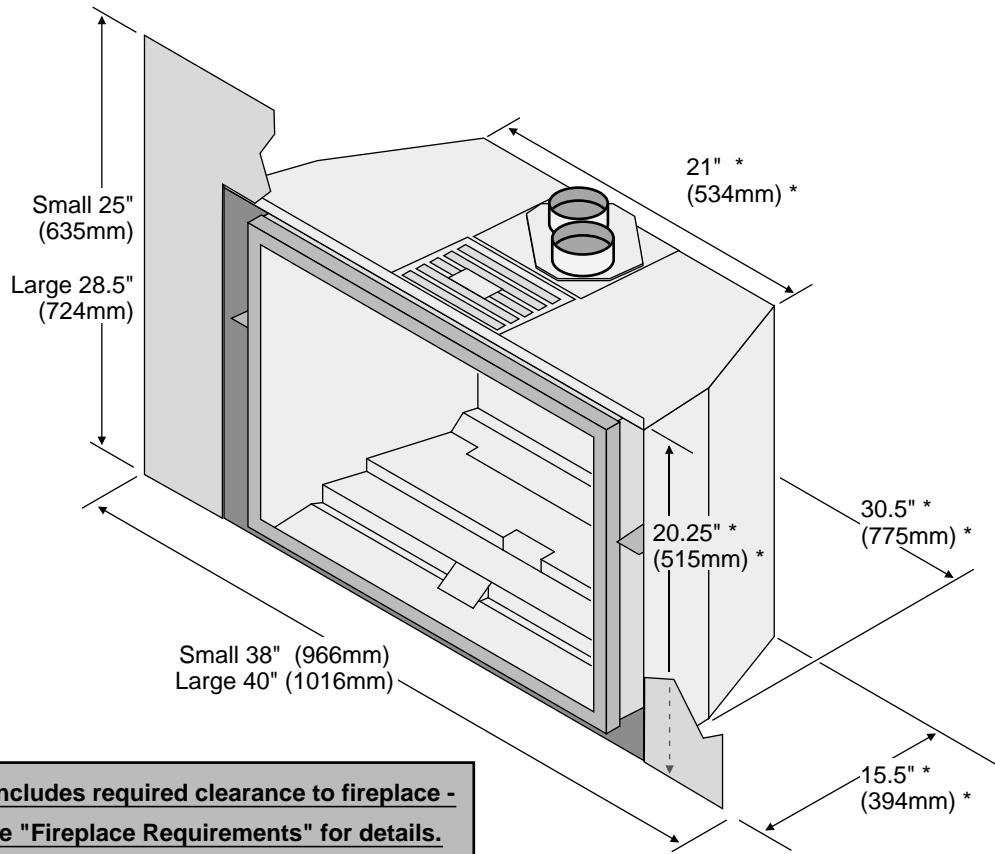

**Electrical Specifications (for blowers)**

Electrical Rating ..... 120 Volts, 2.3 Amps, 60 Hz (275 watt)

**Fuel**

This heater is shipped in natural gas (NG) configuration but may be converted to propane (LP) using the LP Conversion Kit (included) and the LP stepper motor (SKU 94400999, sold separately). The sticker on top of the gas control valve will verify the correct fuel.

## Installation Warnings

---

- Failure to follow all of the requirements may result in property damage, bodily injury, or even death.
- This heater must be installed by a qualified installer who has gone through a training program for the installation of direct vent gas appliances.
- The installation must conform with local codes or, in the absence of local codes, the National Fuel Gas Code, ANSI Z223.1/NFPA 54, or the National Gas and Propane Installation Code, CSA B149.1.
- In Manufactured or Mobile Homes must conform with Manufactured Home Construction and Safety Standard, Title 24 CFR, Part 3280, or, when such a standard is not applicable, the Standard for Manufactured Home Installations, ANSI/NCSCBS A225.1. This appliance may be installed in Manufactured Housing only after the home is site located.
- The heater is designed to operate on natural gas, or propane (LP).
- All exhaust gases must be vented outside the structure of the living-area. Combustion air is drawn from outside the living-area structure.
- Notify your insurance company before hooking up this heater.
- The requirements listed below are divided into sections. All requirements must be met simultaneously. The order of installation is not rigid – the qualified installer should follow the procedure best suited for the installation.

## Packing List

---

- Propane (LP) Conversion Kit
- Remote Control
- "Fireplace Altered" tag (attach to the fireplace)
- 46" Flex Line with Adapter and Shutoff Valve

## Additional Items Required

---

- Faceplate
- 3" Diameter Gas Liner with Termination (Kit – sku 96200330)
- Gas Line Equipment (shutoff valve, pipe, etc.)
- Panel Kit
- Fireback Kit
- Media
- **If using LP (propane) a conversion kit is required (sku 94400999 – GSR Stepper Motor Kit).**

## Order of Installation

---

1. Run gas line to the fireplace.
2. Remove the glass frame.
3. Run vent through fireplace chimney. On larger fireplaces, the vent connector may be left in place. For smaller fireplaces, remove the vent connector. See "Vent Connector Removal and Installation" for details.



**INSTALLATION WARNING:** If using a tall vent (over 25') – you must open the diffuser before attaching the vent. See "Diffuser Adjustment" for details.



**INSTALL THE LIGHT SHIELD (ALL FACES EXCEPT SHADOWBOX).** The light shield (shipped with the face) prevents light from exiting the upper grill area. Install this prior to placing the insert.

4. Place insert into position and attach the gas line and vent.
5. Remove the burner.  
**NOTE:** If using propane (LP), convert the appliance at this time.
6. Install the firebacks.
7. Replace the burner.
8. Install the media (logs, stones - see instructions included with the media).
9. Install the surround panel (see instructions included with surround panel).
10. Follow the instructions under "Finalizing the Installation."

### Fireplace Requirements

- Insert must be placed within a code-conforming masonry fireplace or tested and listed factory-built (metal) wood-burning fireplace. Repair any fireplace damage prior to installation.
- Because the insert uses a circulation blower, clean the fireplace, smoke shelf, and chimney prior to installation.
- This heater may be placed in a bedroom. Please be aware of the large amount of heat this appliance produces when determining a location.
- Do not place insulation or any other material on top of the insert. This may block the upper accent light ventilation, leading to premature bulb failure.

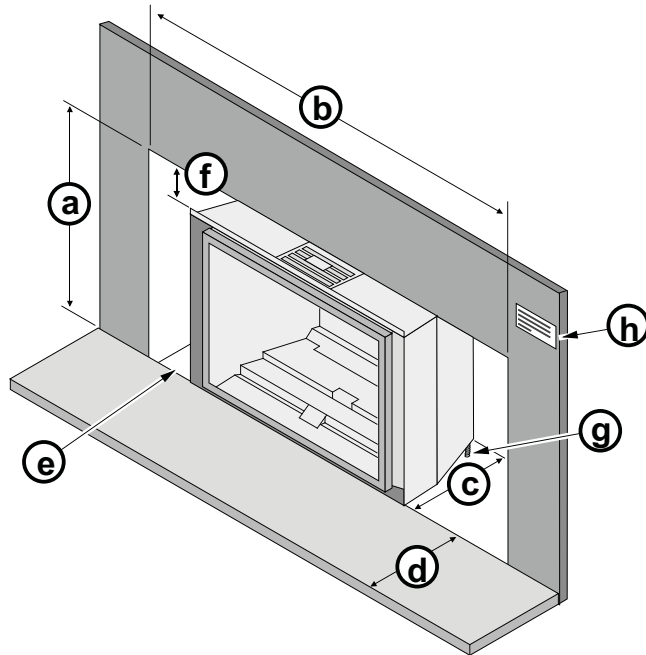

Fireplace Sizing	
(a) Minimum Height	20.25" (515mm)
(b) Minimum Width	30.5" (775mm)
(c) Minimum Depth	15.5" (394mm)
(d) Hearth Depth (see "Hearth Requirements" on the following page for full details)	1.75" (45mm)

- (e) The gas and electrical line should be installed prior to installing the heater.
- (f) For tight fits (under 24") see the section "Removing the Vent Connector".
- (g) See "Leveling Bolts" for details on leveling the heater.

- (h) Attach the "This fireplace has been altered..." plate to the fireplace (use two screws or other suitable method). You may wish to place it in a location where it will be covered by the surround panels.

### Fireplace Clearances to Gas Insert

Side of Insert to Inside of Fireplace	½" (13mm)
Back of Insert to Inside of Fireplace	½" (13mm)
Top of Insert to Inside of Fireplace	¾" (19mm)



## Factory-Built (Metal) Wood-Burning Fireplace Requirements

**NOTE:** Any parts that are removed must be removed in a way that would allow them to be re-installed if the insert is ever removed (removal of rivets or screws is acceptable).

The damper ("A") and grate (with log set) ("B") must be removed (see the illustration below)

The smoke shelf ("C"), internal baffles ("D"), screen ("E"), masonry lining or refractory ("G" & "I"), and metal or glass doors ("F") may be removed (if applicable)

The fireplace must be permanently marked to indicate that it has been altered and is no longer suitable for burning solid fuel (wood), unless the removed parts are re-installed. Cutting of any sheet metal parts is prohibited.

The metal floor ("J") of the firebox may be removed in certain cases\*.

The insulation ("H"), and any structured rigid frame members must not be removed or altered (side and top of door frame, side and top of the face of the fireplace, metal sides, etc.).

The surround panels should not seal ventilation openings on the fireplace.

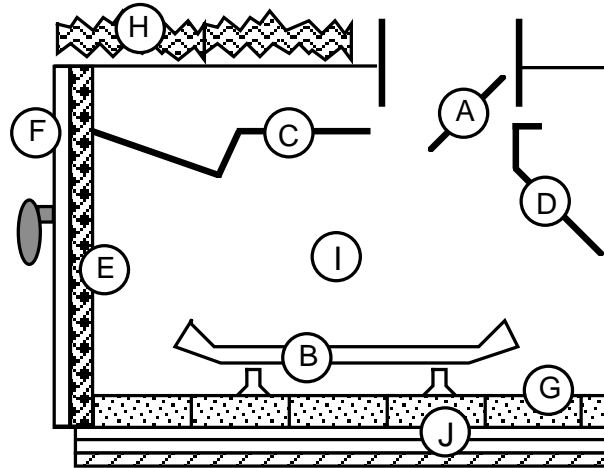

**\*CAUTION:** Firebox floor removal is not covered under the appliance safety standard (ANSI Z21.88 CSA 2.33) used in the safety certification of this appliance. The Intertek safety certification does not apply to this method of installation. Before installing the appliance using this method, contact the Authority Having Jurisdiction to determine if this installation is acceptable in your area. The sheet metal base of the fireplace must be left in place and a minimum 1/2" cement board sheet placed under the entire length and width of the appliance.

If the factory-built fireplace has no gas access hole(s) provided, an access hole of 1.5 inch (37.5 mm) or less may be drilled through the lower sides or bottom of the firebox in a proper workmanship like manner. This access hole must be plugged with non-combustible insulation after the gas supply line has been installed.

## Hearth Requirements

- 1/2" of non-combustible material is required underneath the insert.
- 1/2" of non-combustible material must extend 1.75" (45mm) in front of the insert for the full width of the unit (29.5" / 750mm).

**RAISED INSERTS:** If the insert is raised a minimum of 16" above the flooring (or other combustible material), a non-combustible hearth is not required in front of the insert.

### Leveling Bolts

This heater includes front and rear leveling bolts to accommodate fireplaces with a step-down firebox.

**NOTE:** To access the rear leveling bolts, remove the burner (see page 46).

The leveling bolt holes are shown below.

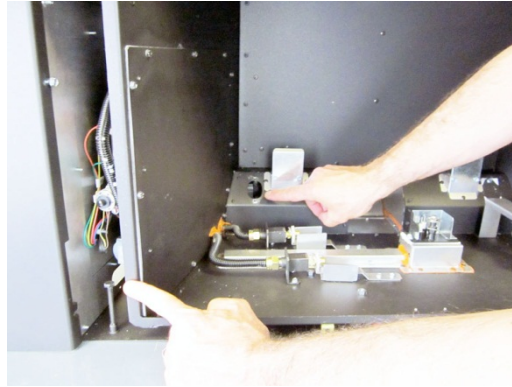

1. Remove the cover and gasket to access the rear leveling bolt. Replace after adjustment.

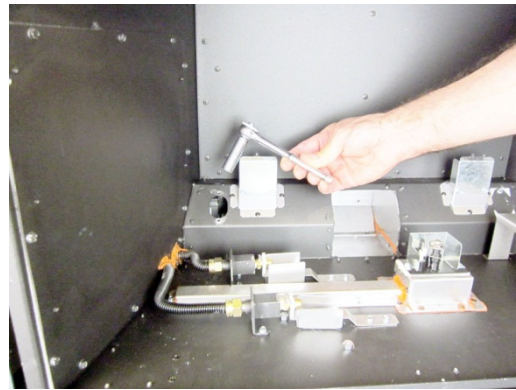
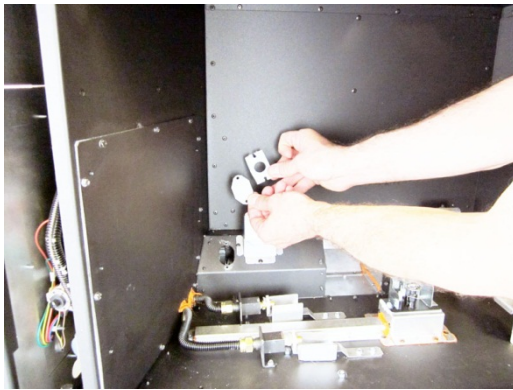

### Electrical Requirements

Travis Industries manufactures a wiring kit specifically for inserts (sku 97200315). This kit allows installers to wire 120 volt AC power into a fireplace directly to the insert, eliminating the need for an external power cord.

- Plug the power cord into a grounded 120 Volt outlet (do not remove the grounding pin).
- The appliance, when installed, must be electrically grounded in accordance with local codes or, in the absence of local codes, with the *National Electrical Code*, *ANSI/NFPA 70*, or the *Canadian Electrical Code*, *CSA C22.1*.

## Clearances

Due to the high temperature of the heater, it should be located out of traffic and away from furniture and draperies.

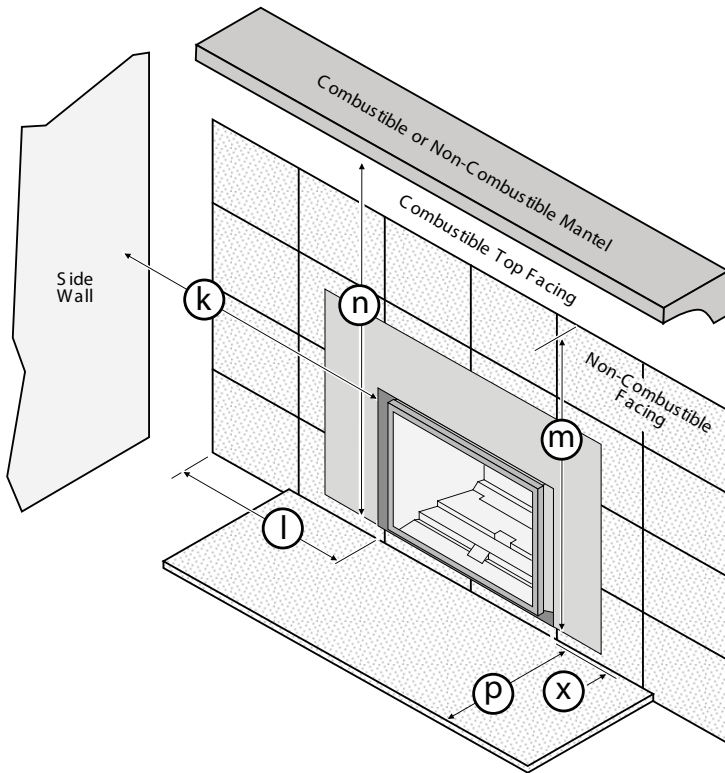

	Minimum Clearances
<b>k Sidewall to Insert</b>	5" 127mm
<b>l Side Facing (non-combustible)</b>	3.375" 86mm
<b>m Top Facing* (non-combustible)</b>	32.375" 823mm
<b>n 12" Mantel* (combustible or non-combustible)</b>	34.5" 877mm
<b>n 4" Mantel* (combustible or non-combustible)</b>	33.5" 851mm
<b>p Hearth Extension to the Front</b>	1.75" 45mm
<b>x Extension onto Hearth</b>	0" 0mm

\* Measured from the base of the insert.

**NOTE:** the non-combustible top facing must extend 32.375" (823mm) above the base of the insert or to the bottom of the mantel (whichever is less).

## Mantel Clearances

The maximum mantel depth is 12" (305mm).

**NOTE:** The combustible area above the facing must not protrude more than 3/4" (20mm) from the facing. If it does, it is considered a mantel and must meet the mantel requirements listed in this manual.

Maximum Mantel Depth

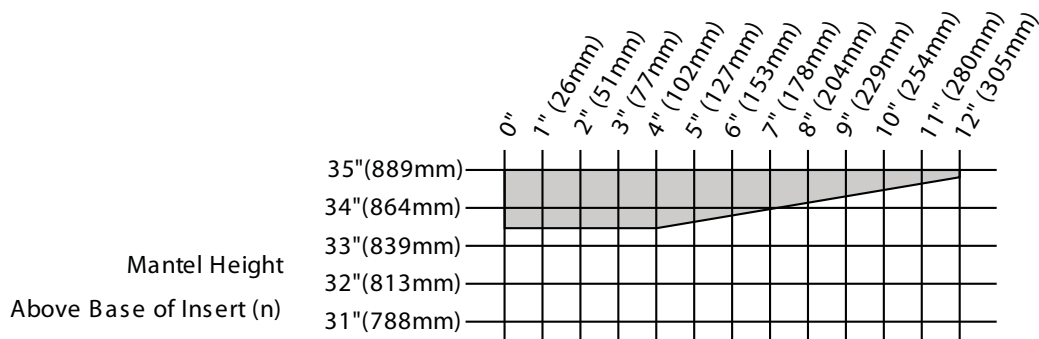

## Gas Line Requirements

### MASSACHUSETTS INSTALLATIONS - **WARNING:**

THIS PRODUCT MUST BE INSTALLED BY A LICENSED PLUMBER OR GAS FITTER WHEN INSTALLED WITHIN THE COMMONWEALTH OF MASSACHUSETTS.

#### OTHER MASSACHUSETTS CODE REQUIREMENTS:

- Flexible connector must not be longer than 36 inches.
  - Shutoff valve must be a "T" handle gas cock.
  - Only direct vent sealed combustion products are approved for bedrooms or bathrooms.
  - Fireplace dampers must be removed or welded in the open position prior to the installation of a fireplace insert or gas log.
  - A carbon monoxide (CO) detector is required in the same room as the appliance.
- The gas line must be installed in accordance with all local codes, if any; if not, follow ANSI 223.1 and the requirements listed below.
  - A manual shutoff valve is required within 3' of the heater. It should be placed upstream of the flex line (if used) and may be installed behind the access door inside the heater.
  - The heater and gas control valve must be disconnected from the gas supply piping during any pressure testing of that system at test pressures in excess of 1/2 psig. For pressures under 1/2 psig, isolate the gas supply piping by closing the manual shutoff valve.
  - Leak test all gas line joints and the gas control valve prior to and after starting the heater.
  - This heater is designed either for natural gas or for propane (but not for both). Check the sticker on the top of the gas control valve to make sure the correct fuel is used (see illustration on page 4).
  - Installation must be performed by a qualified installer, service agency or the gas supplier (In Massachusetts a licensed plumber/gas-fitter).

### Gas Inlet Pressure

	Standard Input Pressure
Natural Gas	7" W.C. (1.74 kPA)
Propane	13" W.C. (2.73 kPA)

- If the pressure is not sufficient, make sure the piping used is large enough, the supply regulator is adequately adjusted, and the total gas load for the residence does not exceed the amount supplied.
- The supply regulator (the regulator that attaches directly to the residence inlet or to the propane tank) should supply gas at the suggested input pressure listed above. Contact the local gas supplier if the regulator is at an improper pressure.

### Directions for Connecting a Gas Pressure Test Gauge

The gas control valve (shown to the left) has two accessible ports for testing line pressure and output pressure. Loosen the brass screw on either test port and place a 5/16" i.d. rubber or plastic tubing over the tapered test port. Connect the tubing to the test gauge.

**WARNING:** The brass screw must be tightened after testing to prevent gas leakage.

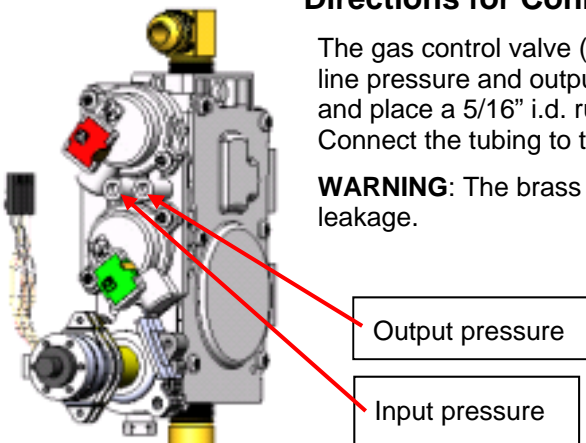

## Gas Line Installation

1. Route the included flex tube through the hole in the left side of the insert and out the front as shown below.



2. Bend the flex tube up.
3. Attach the included gas shutoff valve to the end of the flex tube and gas inlet as shown below. Position so the valve handle is on the right as shown.



Leak-test all gas line connections.



## Vent Requirements

Travis Industries manufactures a vent kit specifically for this insert (sku 96200330). It includes 30' (10M) of vent, hose clamps, and a prairie cap. The flashing on the cap is 18" (458mm) by 18" (458mm).

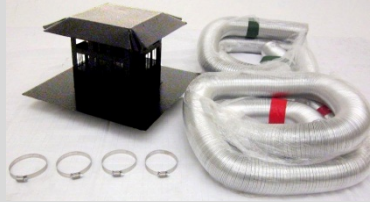

- The gas appliance and vent system must be vented directly to the outside of the building, and never be attached to a chimney serving a separate solid fuel or gas-burning appliance. Each direct vent gas appliance must use its own separate vent system.
- Make sure the exhaust pipe on the heater connects to the exhaust portion of the cap. The illustrations below show how the flex liners should be attached.
- The exhaust vent must reline the entire length of the chimney and terminate above the chimney top.
- Be careful not to crimp or rupture the liner when bending it into chimney offsets.
- When installed, the vent must meet all of the vent manufacturer's requirements.
- Use the following vent:  
3" UL 441 or 1777 Gas Liner for Exhaust, 3" UL 441 or 1777 Gas Liner for Air Inlet  
Duravent 6-5/8" to 3" Co-Linear Adapter and Flashing (46DVA-Gk)  
Duravent High-Wind Vertical Termination (46DVA-VCH) for high-wind applications or Prairie Cap

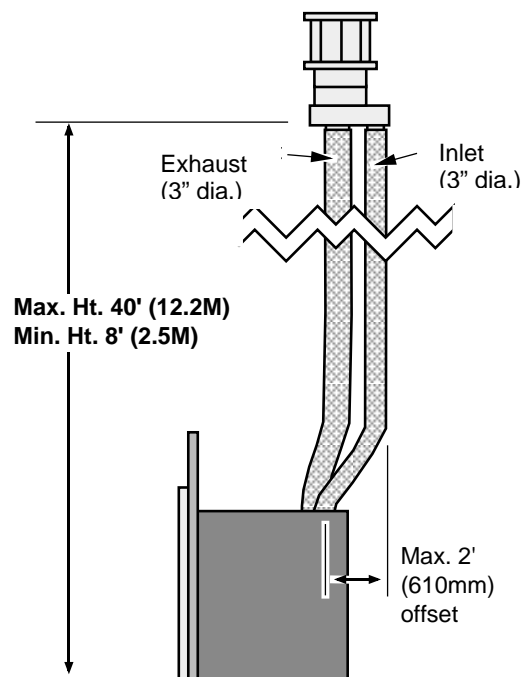

## Altitude Considerations

- This heater has been tested at altitudes ranging from sea level to 6,000 feet (1,800 M). In this testing we have found that the heater, with its standard orifice, burns correctly with just an air shutter adjustment.
- Failure to adjust the air shutter properly may lead to improper combustion which can create a safety hazard. Consult your dealer or installer if you suspect an improperly adjusted air shutter.

## Exhaust Restrictor



Restrictor adjustment should only be done by a qualified installer.

- Set the exhaust restrictor to the position shown in the table below.

**NOTE:** The appliance will slow down within 5 to 10 minutes of startup due to the bi-metallic damper closing. Make sure to wait for at least 10 minutes before assessing flame quality.

**NOTE:** The restrictor positions listed below are based upon laboratory testing. The optimum position may vary slightly.

	<b>Restrictor Settings Traditional Logs</b>
<b>Natural Gas Short Vent (25' or less)</b>	#3 (stock position)
<b>Natural Gas Tall Vent (25' or more)</b>	#4
<b>Propane Short Vent (25' or less)</b>	#2
<b>Propane Tall Vent (25' or more)</b>	#4

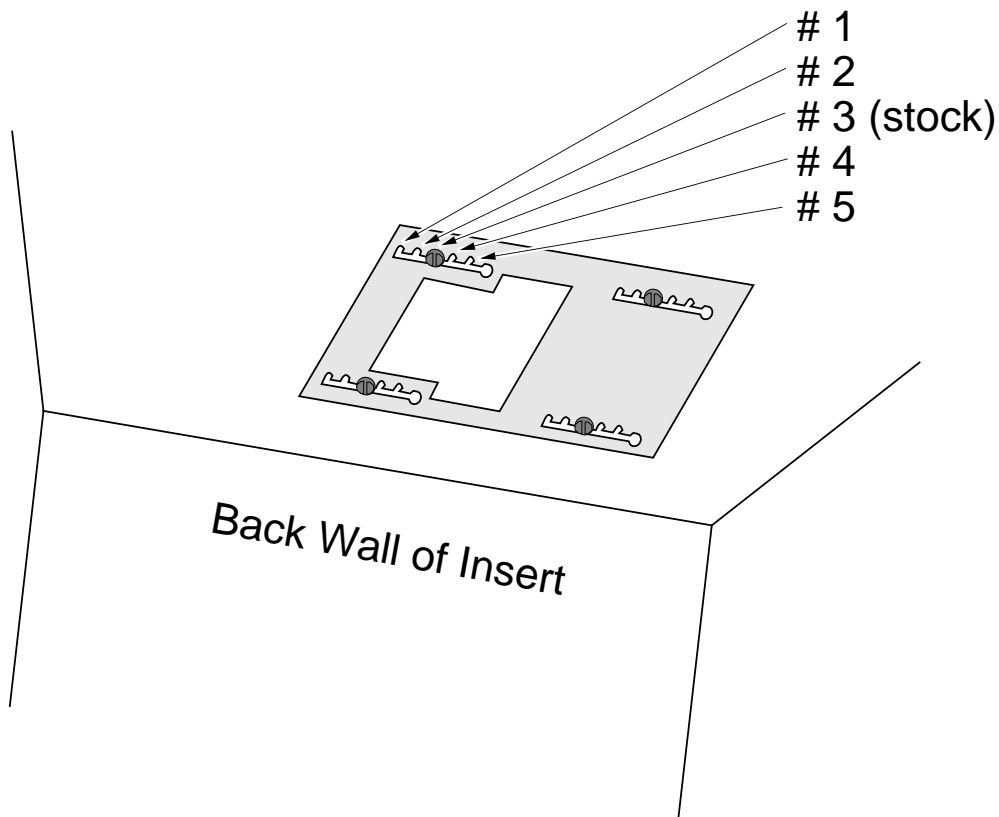

### Adjusting the Exhaust Restrictor

To adjust the restrictor, loosen the 4 screws (a) holding the restrictor in place (1/4" nutdriver).

Slide the restrictor plate to the correct position (b).

Once in place, tighten the screws to secure the restrictor plate in position (c). In the example pictured, the restrictor is in position # 4.

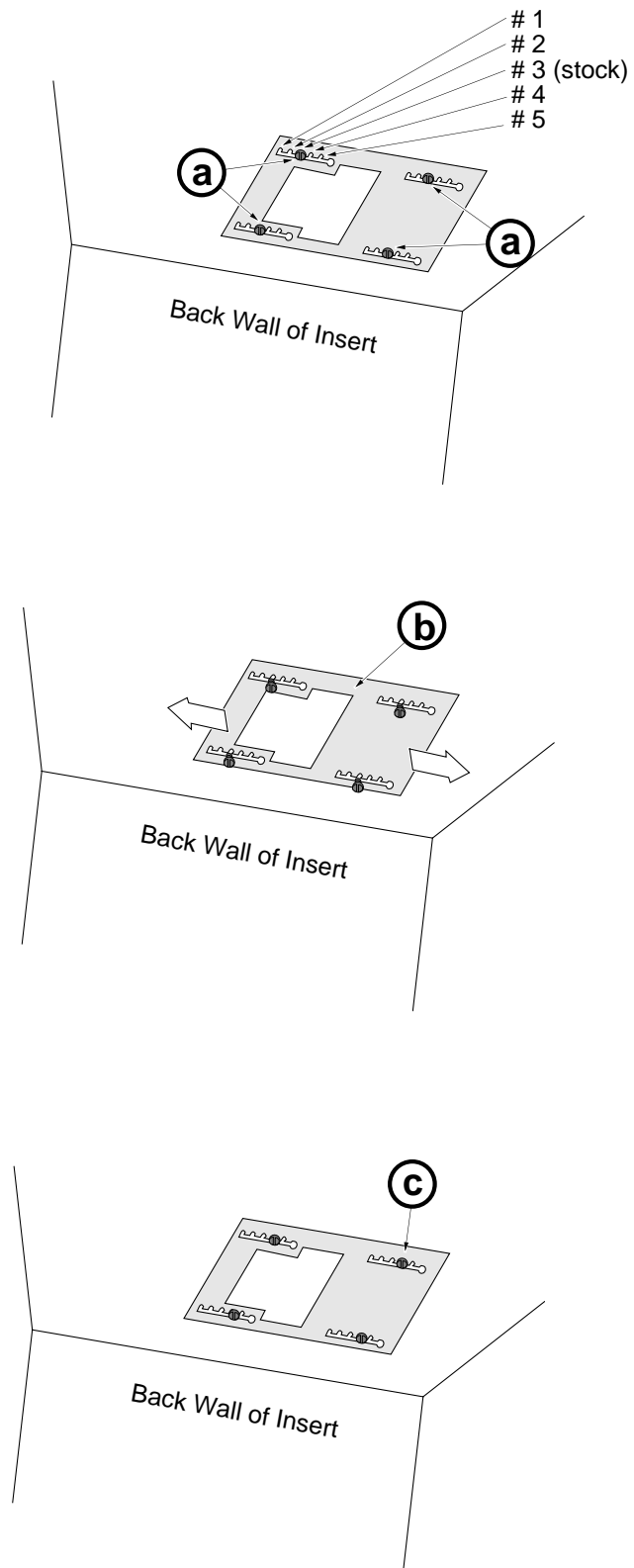



**Diffuser Adjustment**

**Adjusting the Diffuser**

Adjust the diffuser to the setting described in the table below.

	Diffuser
<b>Natural Gas Short Vent (25' or less)</b>	Closed (stock)
<b>Natural Gas Tall Vent (25' or more)</b>	Open
<b>Propane Short Vent (25' or less)</b>	Closed (stock)
<b>Propane Tall Vent (25' or more)</b>	Open

The diffuser must be adjusted before attaching the vent (it is attached to the vent connector and is concealed once the vent is installed). Use a screwdriver or pliers to bend the diffuser to a vertical position.

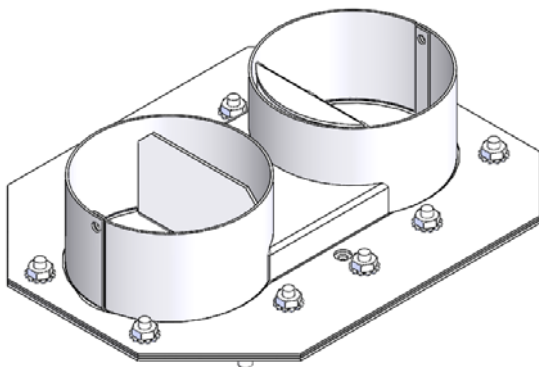
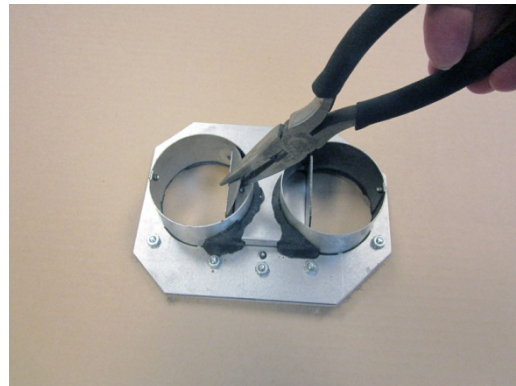
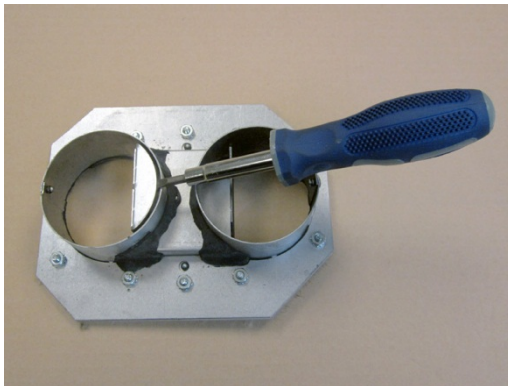

Diffuser Closed (stock)

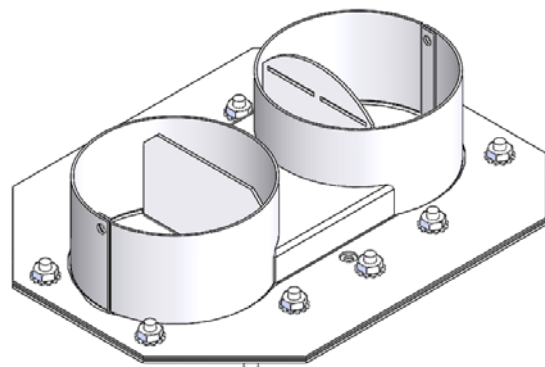

Diffuser Open

**Vent Installation**

Secure the vent to the insert and termination kit using screws.

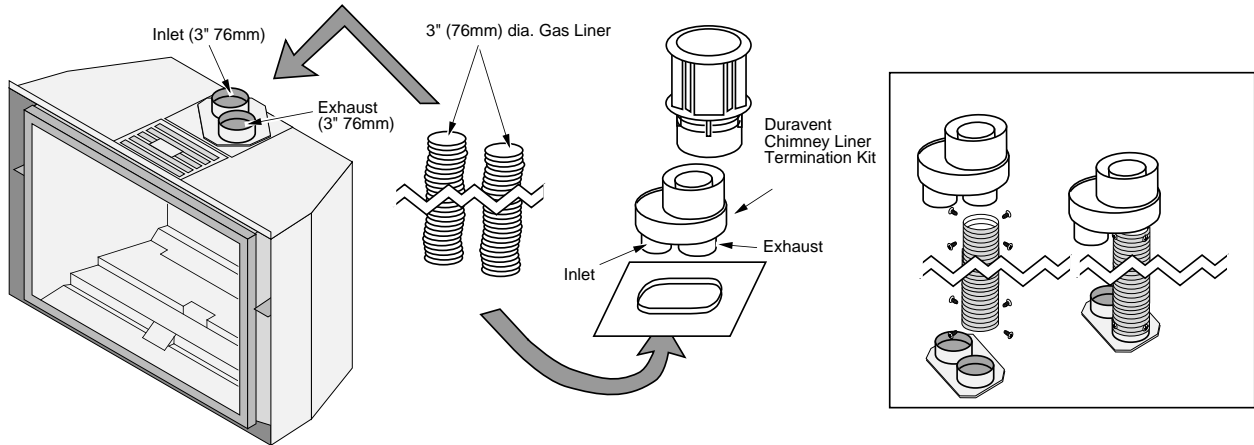

For optimum performance, keep the vent as straight as possible (no 90° bends).

**Vent Location**

- An Exhaust Restrictor is built into the appliance to adjust the flow rate of exhaust gases. This ensures proper combustion for all vent configurations. Depending upon the vent configuration, you may be required to adjust the restrictor position. See "Exhaust Restrictor" on page 15.

**Vent Configurations**

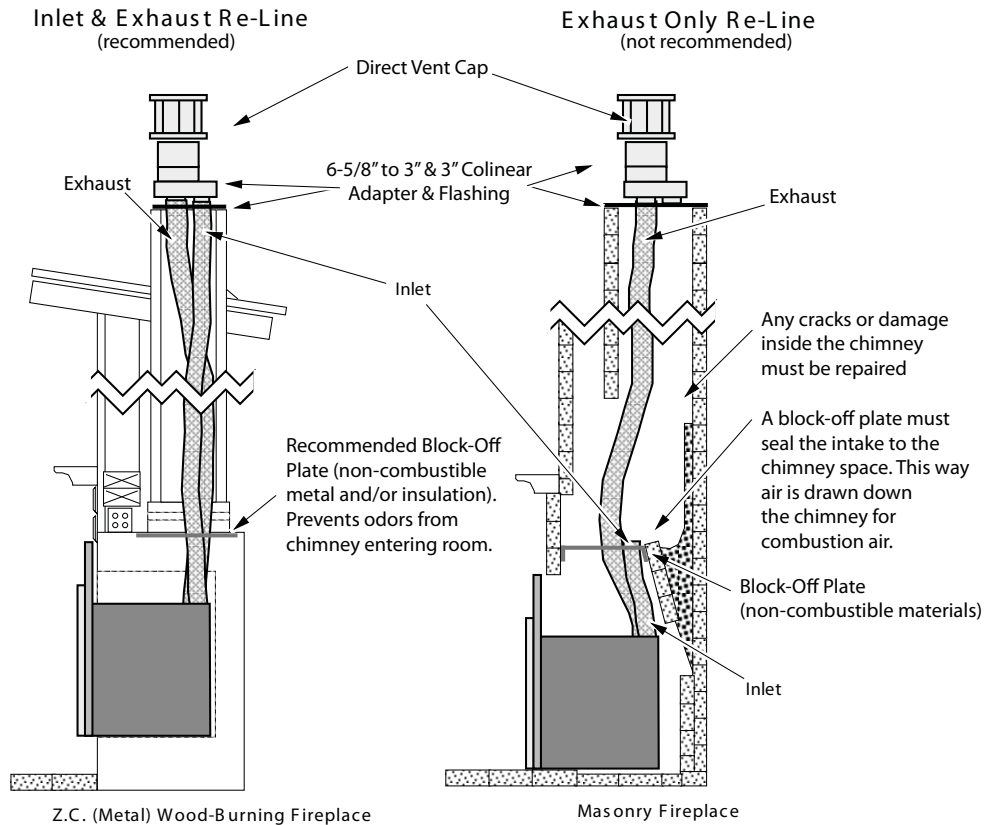

NOTE: You may use either re-line configuration with a masonry or zero-clearance fireplace.

## Vent Attachment – Tight Installations

 The vent connector is shipped attached to the insert, but must be removed to facilitate tight installations. See the directions below for installation.

1. Route the flex vent through the chimney from above (leave an extra 3' at the top). Make sure the flex is thoroughly stretched.
2. Remove the vent connector from the unit and attach it to the flex vent (see the instructions on the following page).
3. Pull on the flex vent until the vent connector is at the same height as the insert. Temporarily attach the flex vent to the top of the chimney (leave extra slack).
4. Slide the insert into place, guiding the vent connector into the guides on top of the insert.
5. Attach the vent connector to the appliance (see the following page for details).
6. Remove any excess slack in the flex line and attach the vent termination.

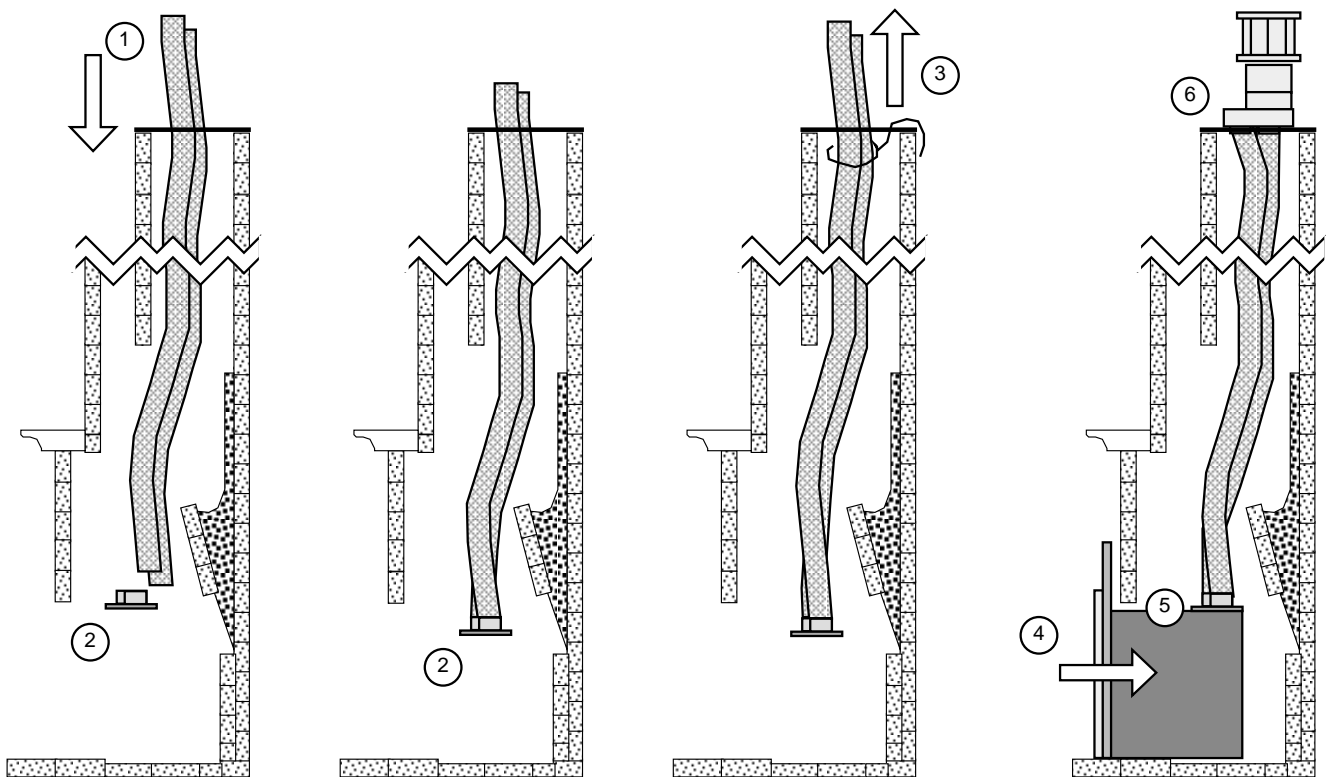

**Vent Connector Attachment**

1. Remove the exhaust restrictor to access the vent connector.



2. Remove these 2 nuts using a 3/8" nutdriver.

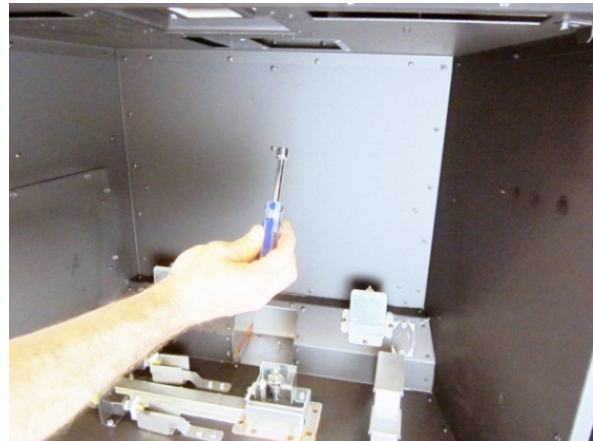

3. Tilt and remove the vent connector.

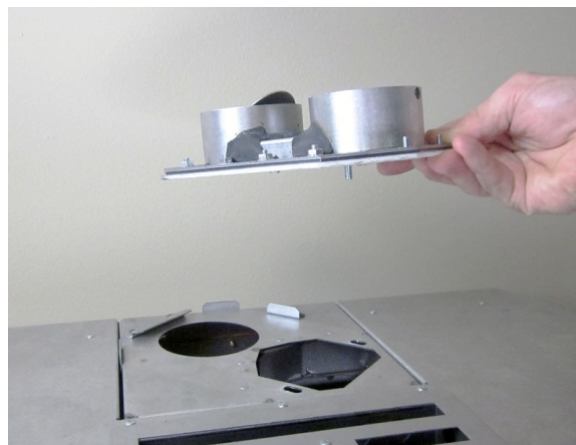



4. Make sure the gasket remains in place. Use silicone, if necessary, to secure the gasket.

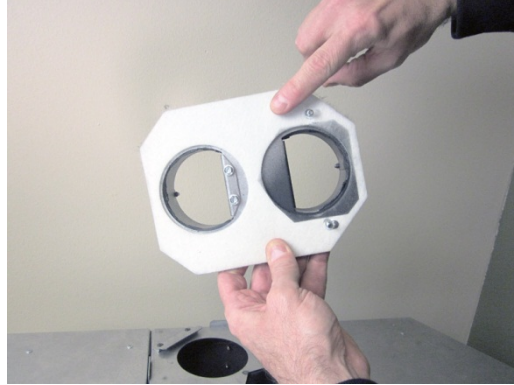

5. Attach the 3" exhaust vent to the connector and secure with at least 3 screws.



6. Attach the 3" intake vent to the connector and secure with at least 3 screws.



- Slide the insert into position. Reach up through the exhaust opening to guide the connector into place. Make sure the gasket remains in place.

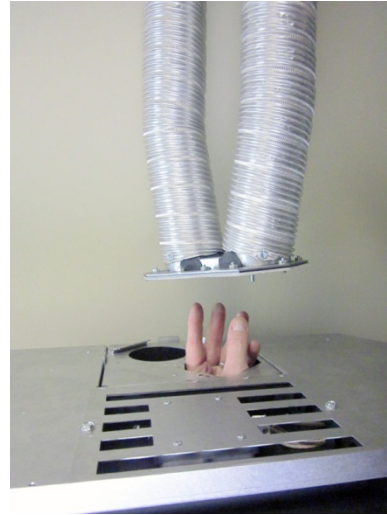

- Slide the vent connector into place, making sure it fits underneath the tab on top of the insert (see step 3 above for additional photos). Continue to pull down on the connector until it is fully seated.



- Re-attach the nuts removed in step 2 to secure the vent connector.
- Replace the exhaust restrictor. Make sure it is in the correct position (see "Exhaust Restrictor" on page 15 for details).

### Glass Frame Removal and Installation



A barrier designed to reduce the risk of burns from the hot viewing glass is provided with this appliance and shall be installed for the protection of children and other at-risk individuals.



If the barrier becomes damaged, the barrier shall be replaced with the manufacturer's barrier for this appliance.



The appliance must be completely cool before removing the glass.  
Do not strike or slam the glass.

1. The glass removal tool is located at the upper right of the convection area and may be removed with a ¼" nutdriver.



**NOTE:** Replace the tool in this location after removing the glass frame.

2. Remove the glass frame as shown below. The glass frame is held in place with three tabs inserted into three slots at the bottom of the insert.

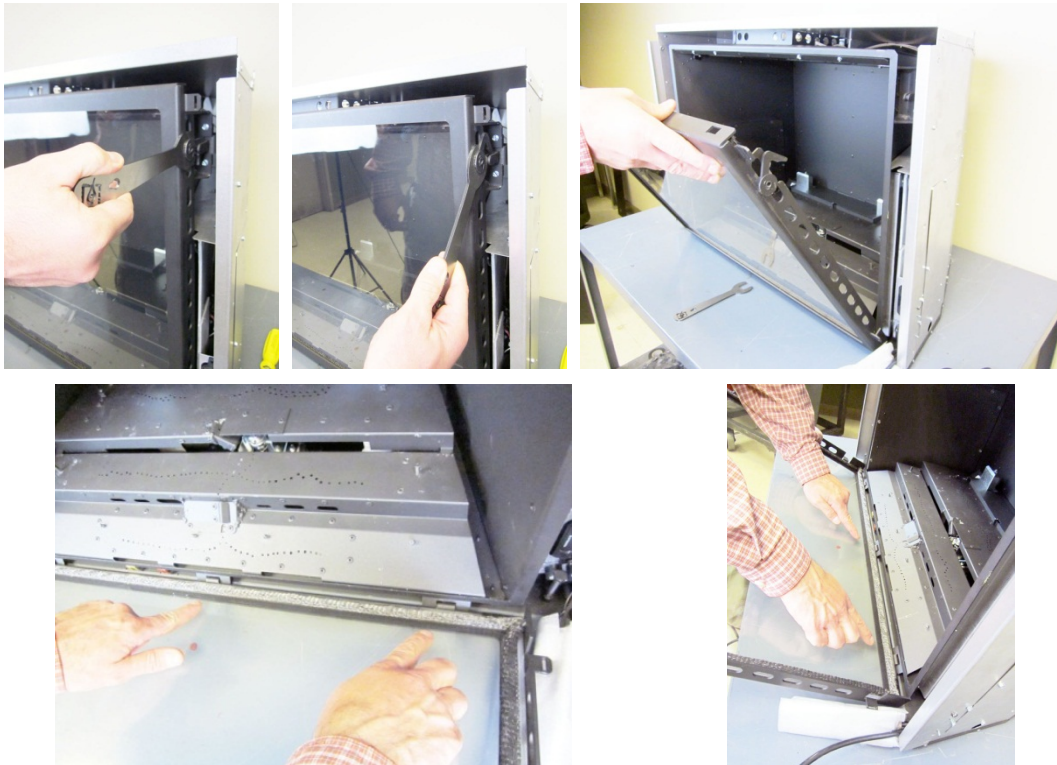

### Steps for Finalizing the Installation

1. Remove the glass (see page 20).

**NOTE:** If using propane (LP) convert the appliance prior to installing the media.

2. We recommend you purge the gas line at this time (with the glass removed). This allows gas to be detected once it enters the firebox, ensuring gas does not build up.
3. Install the four AA batteries (see illustration below). The AA batteries act as a power backup in case the household (AC) power goes out and are required for operation. Install three AAA batteries into the remote (see illustration below). Synchronize the transmitter to the IFC (see page 30).
4. Make sure the accent light bulbs are in place and work correctly.

**NOTE:** Take care to not touch the bulb with your fingers – use a cloth or paper towel).

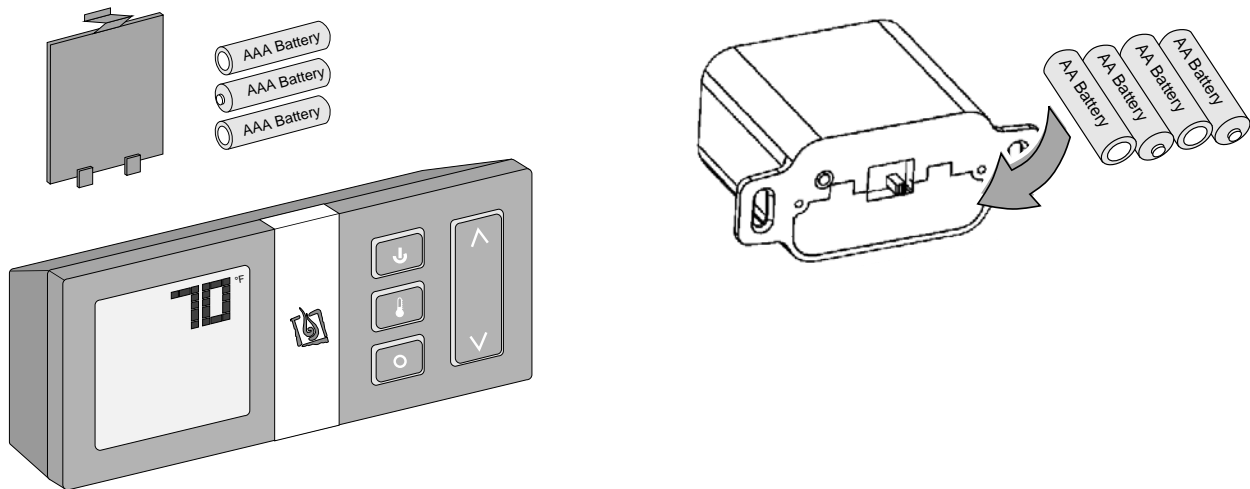

5. Install the media (see the instructions included with the media kit).
6. Replace the glass.
7. Start the heater.
8. Leak test all gas joints.
9. Adjust the air shutter following the directions on the next page.
10. Attach the face following the directions included with the face.
11. Adjust the flame to its highest position - the flames should not contact the top of the firebox. Check the flame on low position. The flames should burn off of each burner hole. If the heater does not work correctly, contact your Travis dealer for a remedy.
12. Give this manual to the home owner for future reference and fully explain operation of this heater.



## Air Shutter Adjustment

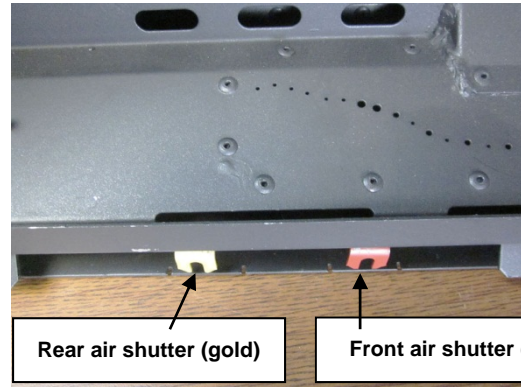
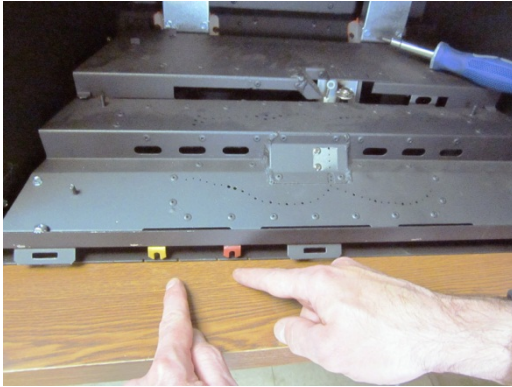

Left = More Air

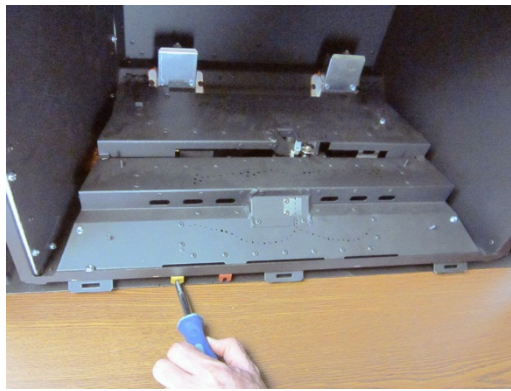

Let the heater burn for fifteen minutes (make sure the media and glass are in place). The flames should be yellow with no sooting. Adjust the air shutter, if necessary, to achieve the correct looking flame.

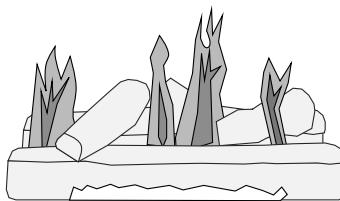

**Correct**

Flames should be blue at the base, yellow-orange on the top.

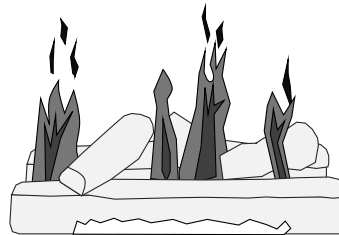

**Not Enough Air**

If the flames are too tall or sooty on the ends, open the air shutter.

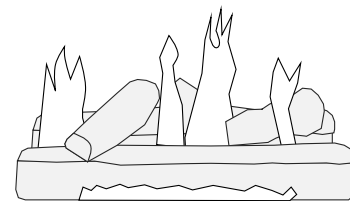

**Too Much Air**

If the flames are all blue and short, close the air shutter.

**Burner Removal**

1. Remove the burner attachment screws (there are 2 in the front and 1 in the rear) using a ¼" nutdriver.



2. Remove the rear burner.



3. Remove the front burner as shown below.

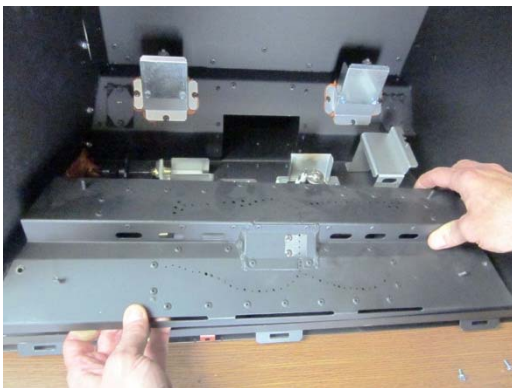



4. Install the firebacks (see the instructions included with the firebacks for details).

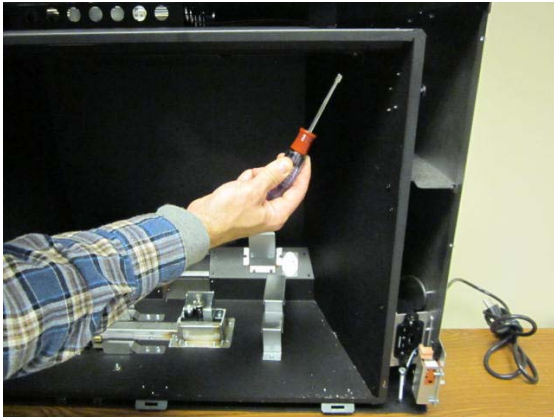

The side fireback clip has a keyhole slot. It can be removed by loosening the screw and sliding the clip out.

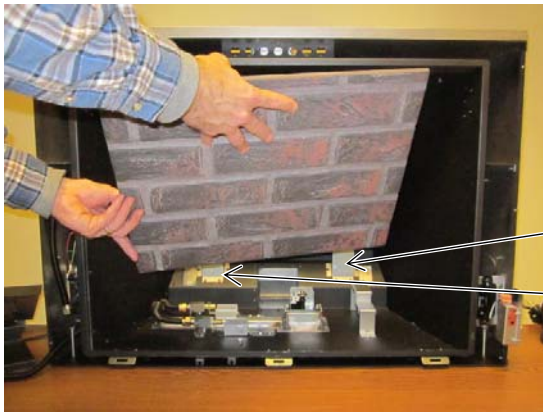
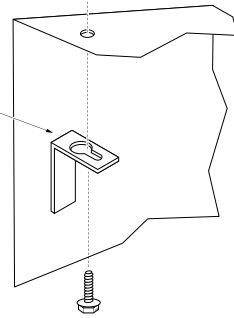

### **430 Light Shields**

Remove the two light shields on the 430 before installing the fireback. Replace after firebacks are in place.

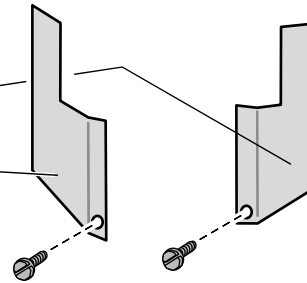

5. Replace the front burner as shown.

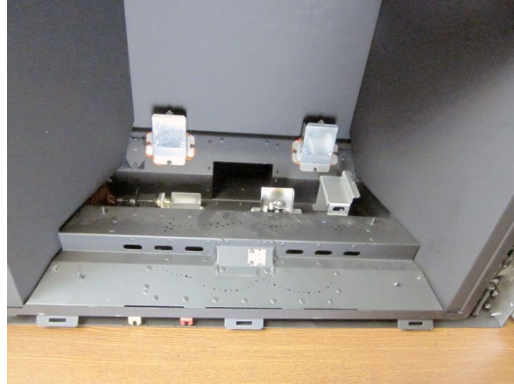

6. Replace the rear burner as shown.

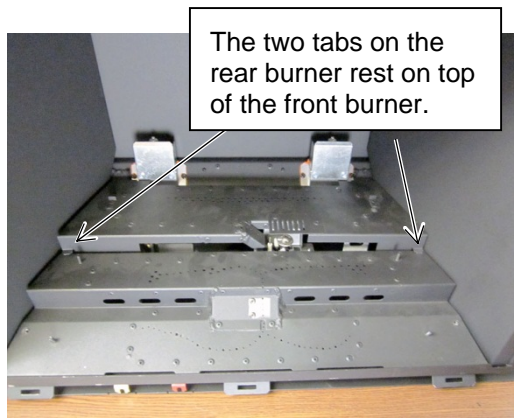

7. Re-attach the burner attachment screws (see step 1).

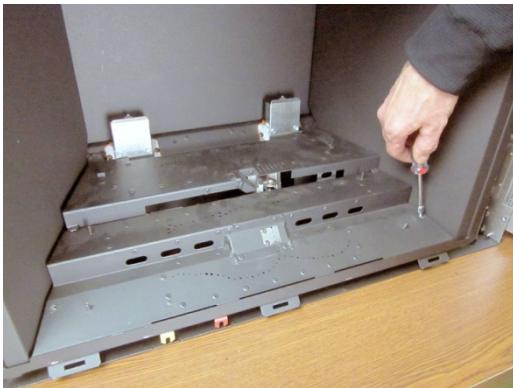

## Before You Begin

- Read this entire manual before you use your new heater (especially the section "Safety Precautions" on pages 4 & 5). Failure to follow the instructions may result in property damage, bodily injury, or even death.

### Remote Control Warnings

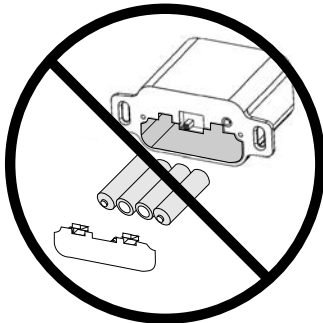

**KEEP BATTERIES AND COVER  
INSTALLED AT ALL TIMES**

The remote control system requires the batteries and battery cover to remain in place at all times. Once the batteries or cover are removed, the system may re-start in standing pilot mode. If this occurs when the heater is in Remote Mode, you will not be able to turn the heater off manually from the battery box.

If you need to replace dead batteries, make sure to **turn the appliance off** before removing the batteries.

**NOTE:** If the batteries go dead, the system will operate normally as long as household power (120v AC) is present.



The transmitter and IFC are radio frequency devices. Placing the transmitter in or near metal may severely reduce the signal range.



Turn off the main gas supply to the appliance during appliance installation, maintenance, or in case of remote control malfunction.

## Remote Set-Up

### Verify the Switch is on “REMOTE”

The battery holder has a switch built into it (see **Figure 1**). This switch must remain in the REMOTE position for the remote to operate.

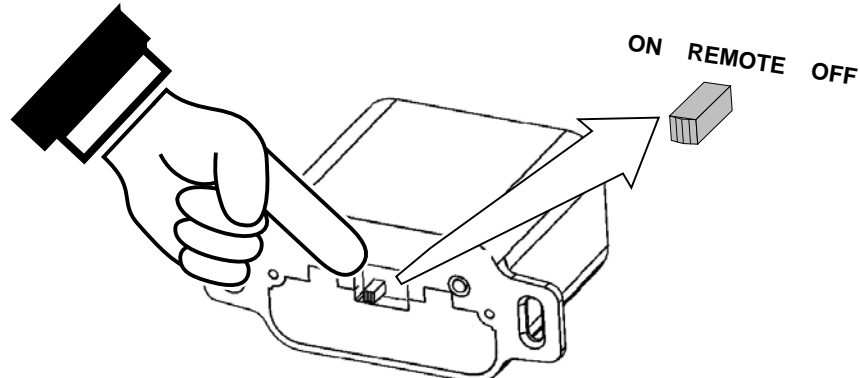

Figure 1

### Synchronize the Transmitter to the IFC

The transmitter will need to be synchronized to the IFC (Integrated Fireplace Control) before the remote will work correctly. Synchronizing is done in the following two steps below (see **Figure 2**):

1. Press the PRG (Program) button on the battery box (IFC will beep 3 times).
2. Press the “ON” button on the transmitter (IFC will beep 3 times).

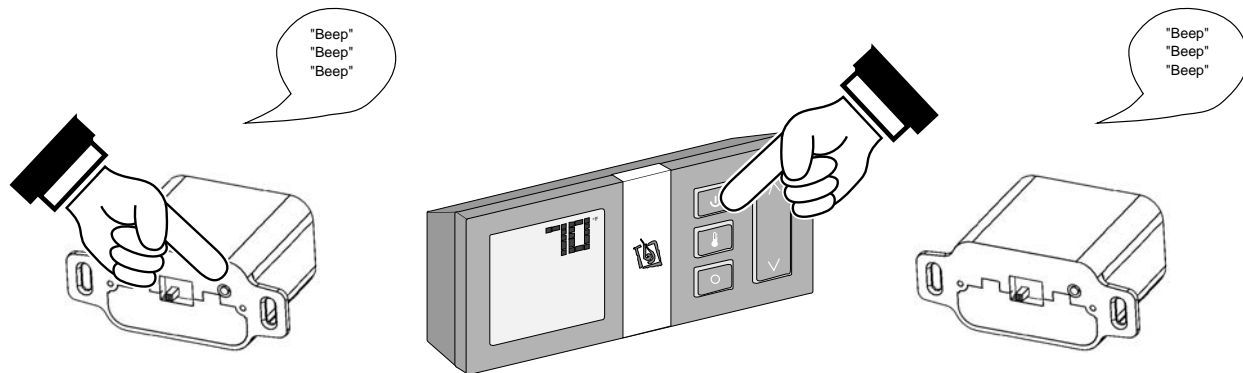

Figure 2

**NOTE:** If power is cut off to the IFC for an extended period of time, you may need to re-synchronize the remote.

### Clearing the System Memory

This appliance uses an Integrated Fireplace Control (IFC) to store the unique code for the remote control. If you wish to clear the system memory, **MAKE SURE GAS IS TURNED OFF TO THE APPLIANCE** then press the PRG (Program) button for 10 seconds. The pilot will start to spark repeatedly, signifying all system memory has been cleared. The system will return to its original configuration: a remote will need to be synchronized; and, the system will operate under continuous pilot mode.

## Starting the Heater for the First Time

- Burn the heater at a high setting with the blower off for an extended period (up to 48 hours). This will cure the painted surfaces. **Fumes** from the paint curing and oil burning off the steel will occur. This is normal. We recommend opening a window to vent the room.
- **Condensation** may appear on the glass each time you start the heater - this is normal.
- **Blue Flames** will occur on the heater when it first comes on. After fifteen minutes the flames will turn a more realistic yellow and orange color.
- Verify the batteries are installed (see page 37).

## Location of Controls

Most features will be controlled by the included remote.

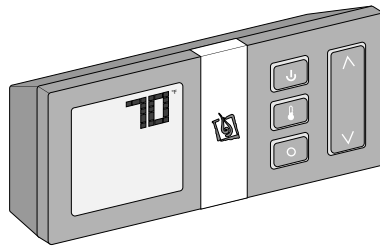

## Direct Operation

The fireplace may be directly operated from the battery holder (accessed by removing the face). The three positions are below (see Figure 3):

**ON** – Burner turns on (regardless of transmitter settings).

**OFF** – Burner turns off (regardless of transmitter settings).

**REMOTE** – Burner is controlled by the transmitter.

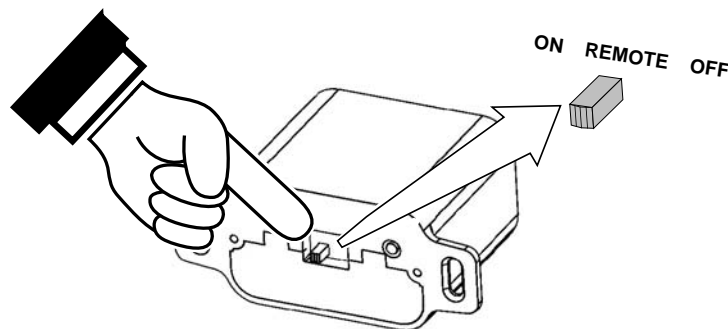

Figure 3

**NOTE:** When the battery holder switch is turned to ON or OFF, the mode settings (Flame Height, Comfort Control) will remain in the same state as before the switch was moved (i.e.: the IFC “remembers” the last setting). If you wish to adjust the mode settings use the transmitter mode button to adjust the settings. The thermostat and burner on/off operating functions will not work on the transmitter.



## Continuous/Intermittent Pilot Switch

This heater may run with the pilot continuously running or in intermittent mode. For most homeowners, the intermittent mode is preferred (this saves fuel, doesn't give off un-needed heat). However, in some situations the homeowner may prefer to switch the heater to continuous pilot. The most typical reasons for switching to continuous pilot are:

- Very Cold Conditions – in very cold conditions you may notice that the burner does not light quickly, and the flames lift off the burner. If this is situation, we recommend you switch to continuous pilot. This will create a slight draft in the vent, allowing for the burner to light quickly and draft correctly.
- Excessive Condensation on Glass After Startup – certain installations may encounter excessive fogging on the window after startup (not just the first time the heater was started). This is an aesthetic condition that may be remedied by switching the heater to continuous pilot.
- Cold Glass or Heater Front – in very cold conditions you may notice that the heater front and glass become very cold. To remedy this, switch the heater to continuous pilot.
- Frequent On / Off Operation – if you are frequently turning the heater on and off, you may wish to leave it in continuous pilot. This allows the burner to turn on more quickly, without pilot ignition delay.

### Switching from Intermittent (IPI) to Continuous Pilot (CPI)

The pilot mode on this appliance is adjusted using the remote. With the remote in the off position (thermostat off, manual off), follow the directions below to adjust the pilot mode.

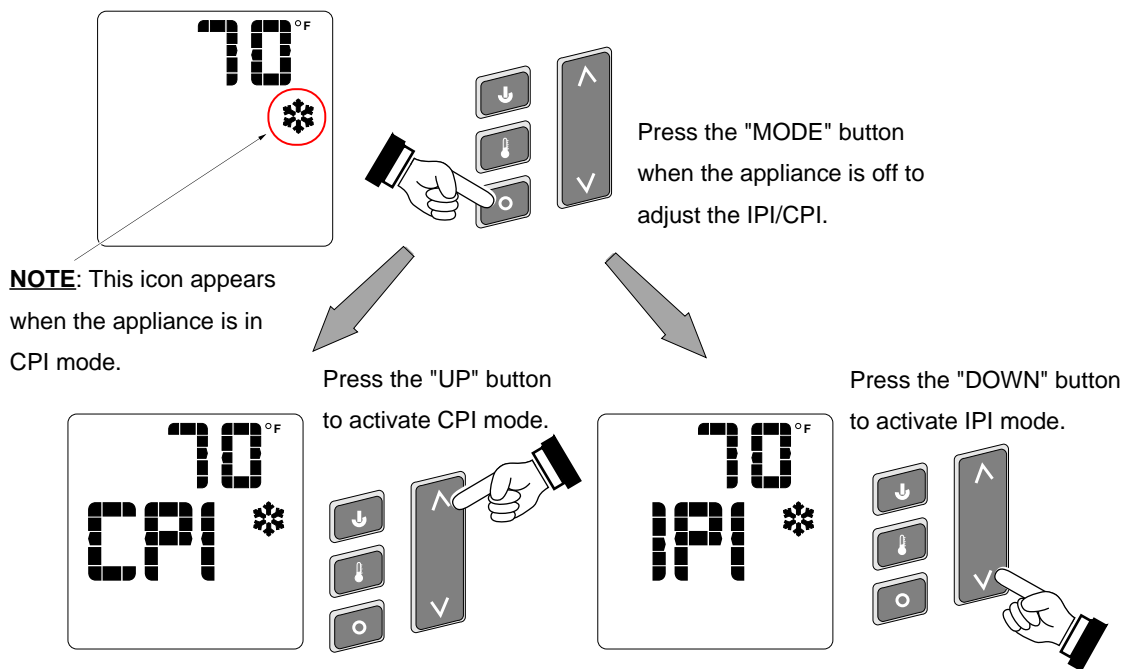

Figure 4



## Remote Operation

When the switch on the battery holder is set to “REMOTE” the transmitter operates the fireplace. Once you understand how the transmitter works, you will be able to operate your fireplace quickly and easily.

### Display Overview

The transmitter display has four main sections (see **Figure 5**).

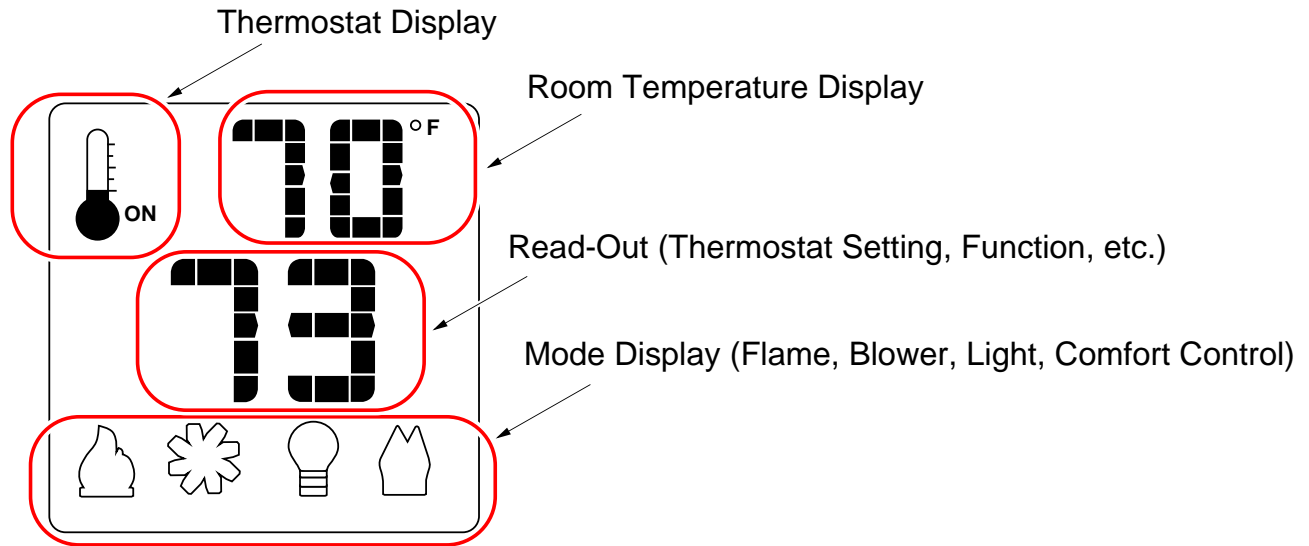

Figure 5

### Listen for the “Beep”

Each time you press a button on the transmitter that controls the fireplace, a “beep” will sound from the IFC. When you change thermostat target settings the IFC will not beep.

**NOTE:** When the batteries start to get low, the IFC will beep twice whenever a button is pressed. When the batteries are nearly depleted, the IFC will no longer beep. See “IFC Batteries” on page 37).

## Manual On-Off / Smart Thermostat / Standard Thermostat

Use the thermostat button to cycle through the three thermostat settings (see Figure 6).

Look here for the thermostat setting.

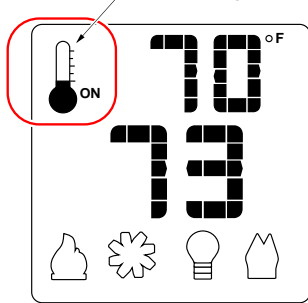

Press the thermostat button to cycle through the thermostat settings.

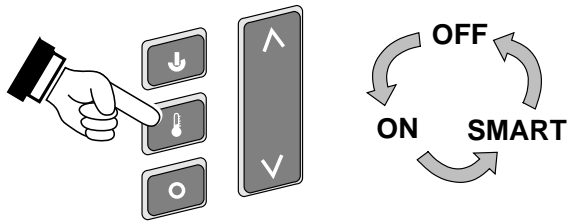
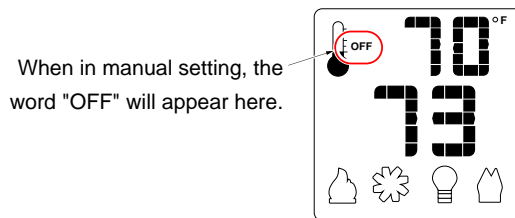

Figure 6

- **MANUAL ON/OFF** – The burner will turn on and off using the remote (see Figure 7). Press the On/Off button to control the burner. When off, the display will only show the current temperature.



When in manual setting, the word "OFF" will appear here.

Figure 7

- **SMART THERMOSTAT** – While in smart thermostat, the transmitter will control the burner to achieve the target temperature (see Figure 8 below). Flame height will be adjusted up or down to allow operation without turning the burner on and off (also called "smart modulation"). To adjust the target temperature, press the UP and DOWN buttons until a suitable temperature is achieved.

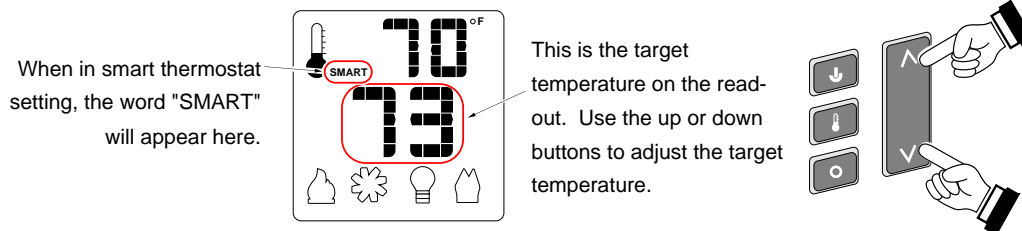

When in smart thermostat setting, the word "SMART" will appear here.

This is the target temperature on the read-out. Use the up or down buttons to adjust the target temperature.

Figure 8

- **STANDARD THERMOSTAT** - While in standard thermostat setting, the transmitter will turn the burner on and off to achieve the target temperature (see Figure 9 below). To adjust the target temperature, press the up and down buttons until a suitable temperature is achieved.

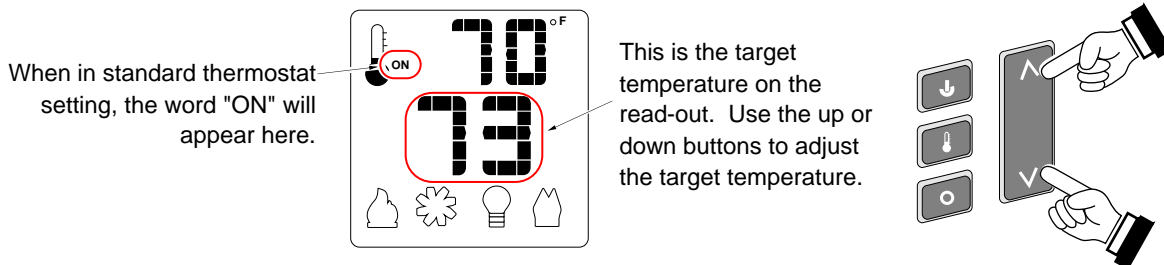

When in standard thermostat setting, the word "ON" will appear here.

This is the target temperature on the read-out. Use the up or down buttons to adjust the target temperature.

Figure 9

**NOTE:** If the transmitter batteries go dead while in thermostat setting (standard or smart), the appliance will shut off after approximately 24 hours.

### Mode Controls (Flame, Blower, Light, Comfort Control)

Use the mode button to cycle through the four mode controls (see Figure 10 below).

Press the mode button to cycle through the mode settings.

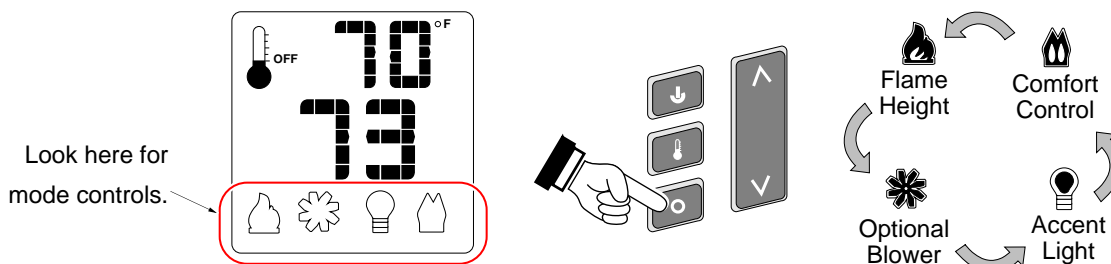

Figure 10

#### Flame Height

Flame height may be controlled using the UP and DOWN buttons when in Flame Height Mode (see Figure 11 below). The center display will display the 7 settings, from “OFF” to “HI” for full on.

**NOTE:** Flame height may not be adjusted if operating in Smart Thermostat setting.

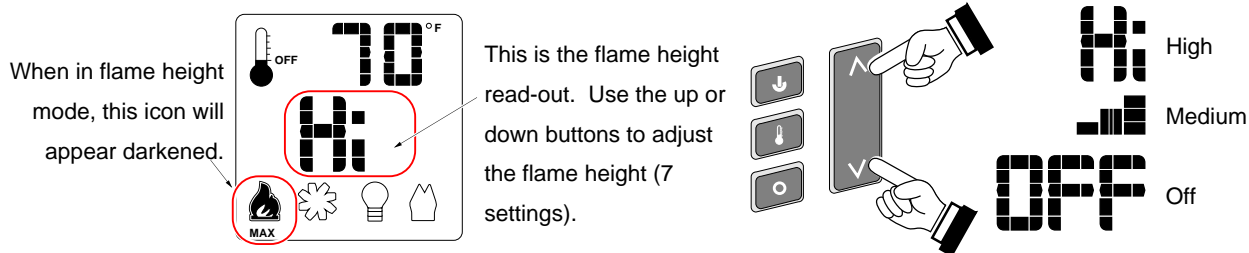

Figure 11

#### Blower Speed

The blower may be controlled using the up and down buttons when in Blower Speed Mode (see Figure 12). The center display will display the 7 settings, from “OFF” to “HI” for full on.

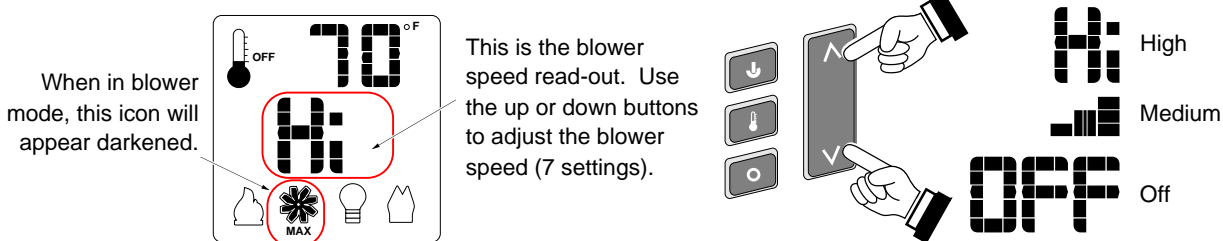



Figure 12

**MANUAL MODE – BLOWER OPERATION**

When in Manual Mode the blower will remain on, even if the burner is turned off and the heater cools.

Either manually turn the blower off, or turn off the heater by pressing the On/Off button. 

**Mode Controls (continued)**

**Accent Light**

The Accent Light (night light) inside the heater may be turned on and off using the up and down buttons when in Accent Light Mode (see Figure 13). The center display will display the 7 settings, from “OFF” to “HI” for full on.

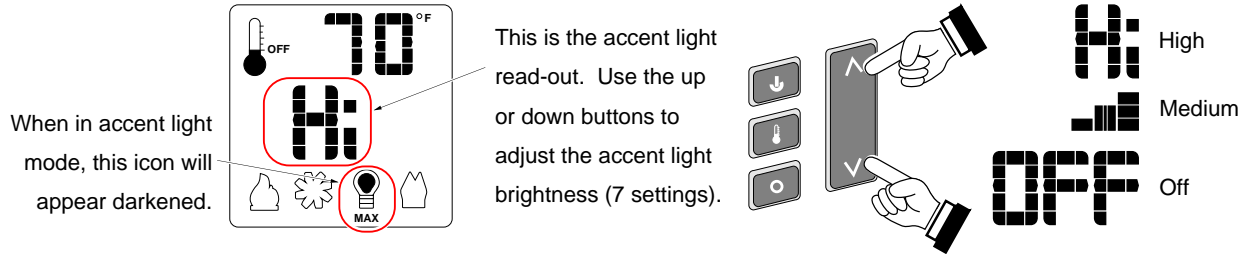
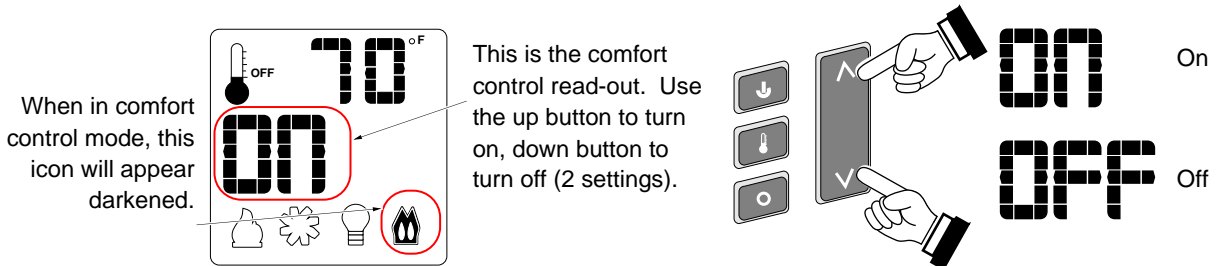

**Figure 13**

**HINT:** If you wish to leave the accent light on while turning the burner off, adjust the Flame Height to “OFF” (see above).

**Comfort Control (rear burner)**

The comfort control (rear burner) may be turned on and off using the up and down buttons when in Comfort Control Mode (see Figure 14). The center display will display either “ON” or “OFF”.



**Figure 14**

**Display Fahrenheit or Celsius**

- With the system in the “OFF” position, press both the MODE and THERMOSTAT buttons simultaneously to toggle between Fahrenheit (F) and Celsius (C).

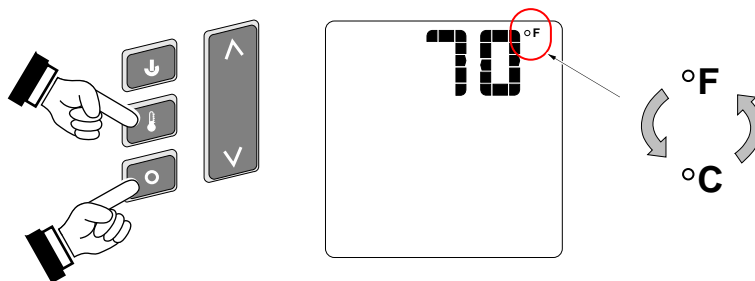

**Figure 15**

## Low Battery Indicator

### Transmitter Batteries

The transmitter has a battery-level indicator. When it indicates low battery voltage (see Figure 16 below), install three new AAA alkaline batteries into the transmitter (see “Transmitter Battery Installation” on page 37).

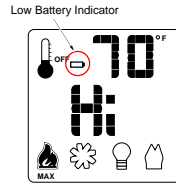

Figure 16

### IFC Batteries

The IFC (Integrated Fireplace Control) will “beep” twice when a transmitter button is pressed when the batteries are low. Install four new AA alkaline batteries into the battery box when this occurs (see “Battery Installation” on page 37). In applications where the appliance is required to provide heat, we recommend replacing the batteries before each heating season.

## Battery Replacement

### Battery Installation

Install four AA batteries into the battery holder (see Figure 17 below). These batteries act as a power backup in case the household (AC) current goes out.

### Transmitter Battery Installation

Install the three included AAA batteries into the remote.

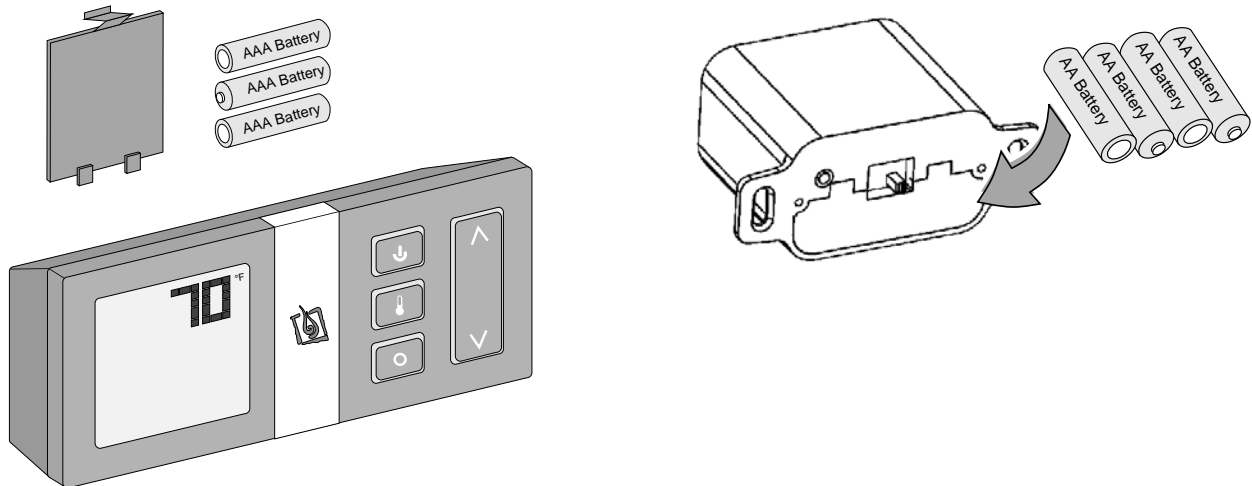

Figure 17

## Power Outages

The remote will work if household current (AC power) is disconnected. The batteries inside the battery box will continue to power the heater but the accent light and blower will not operate.

## Child-Proof Feature

The child-proof feature disables the control buttons, preventing un-wanted use of the remote.

- Press both the MODE and UP buttons simultaneously to turn this feature on and off.

**HINT:** This feature is especially useful while using the thermostat setting.

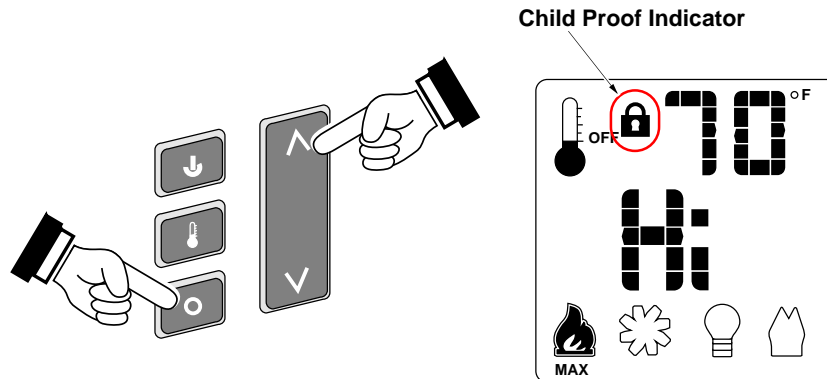
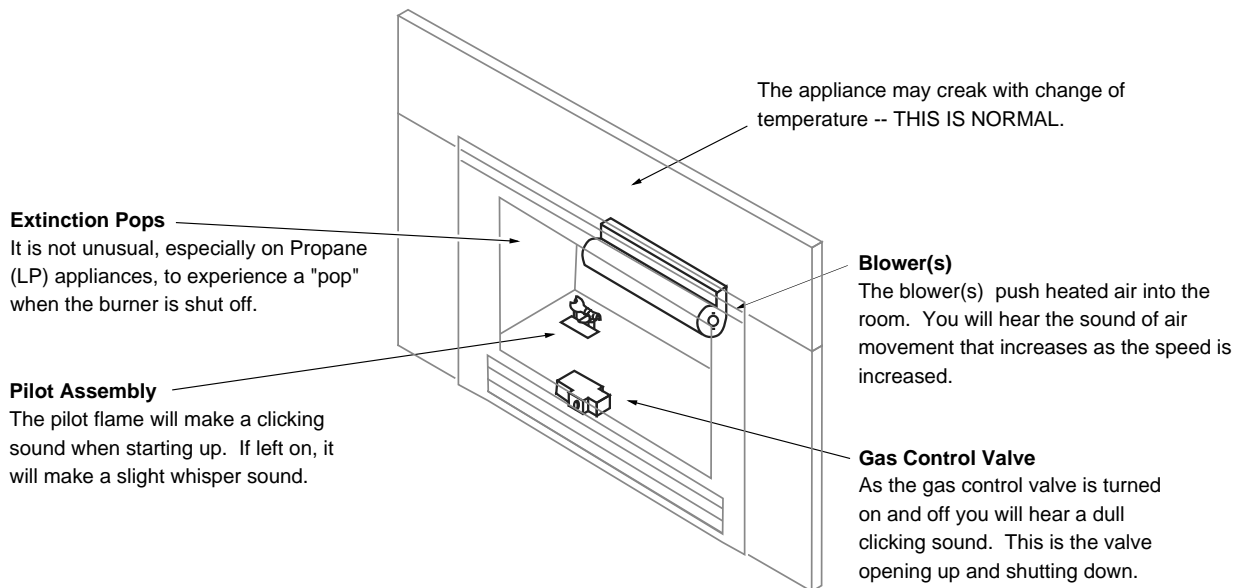

Figure 18

## Normal Operating Sounds



## Normal Operating Odors

This appliance has several areas that reach high temperatures. Dust or other particles on these areas may burn and create an odor. This is normal during start-up. You may notice the smell is more acute if the appliance was left idle for a long period.

**DANGER HIGH VOLTAGE:** Disconnect power before attempting maintenance or repair.

## Maintaining Your Heater's Appearance

Fingerprints or other marks left on the optional plated surface may become etched in place if they are not wiped clean prior to turning the heater on. Clean the plated surfaces with denatured alcohol and a soft cloth (with the heater cool). Other cleaners may leave a film that may become etched into the surface.

## Accent Light Replacement

The accent lights in your heater provide additional lighting. The bulbs will burn out over time. To replace, follow the directions below:

1. Shut off gas to the heater and let it cool for 15 minutes.
2. Remove the glass (see page 20) and media.
3. Replace the halogen bulbs with the following bulbs:

**NOTE:** Take care to not touch the bulbs with your fingers – use foam packing or a paper towel to handle the bulbs:



35 Watt 120 Volt T4 Halogen Bulb (G6.35 Base)

### Lower Accent Lights

The lower accent lights are located at the back of the firebox behind the light deflector as shown below. They can be removed by pulling them out.



### Upper Accent Lights

The upper accent light can be accessed by removing the 4 screws with a 1/4" nutdriver, as shown below.



The upper accent light assembly drops down to expose the accent light.



When replacing the assembly, carefully insert the wiring into this cavity to ensure the wiring is not pinched.

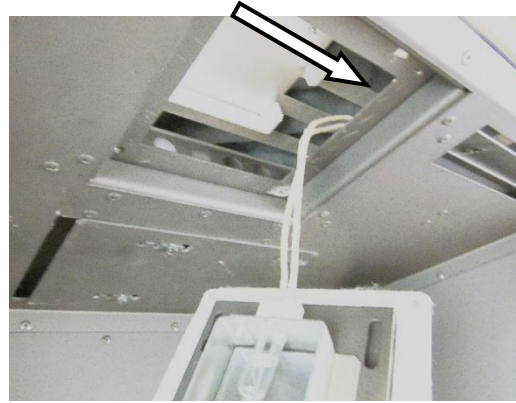
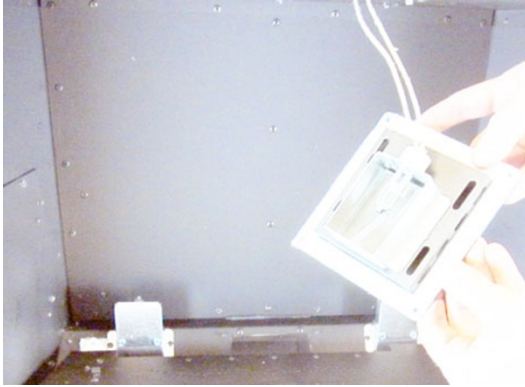

The upper accent light may now be accessed.

Loosen the two screws nearest the bulb to disengage the bulb from the holder. Remove the bulb from the holder. Replace the bulb, making sure not to touch the bulb with your fingers (grasp the bulb with the bulb packaging or a paper towel). Tighten the screws until the bulb is secure (do not over-tighten, as this may damage the electrical contacts on the bulb).

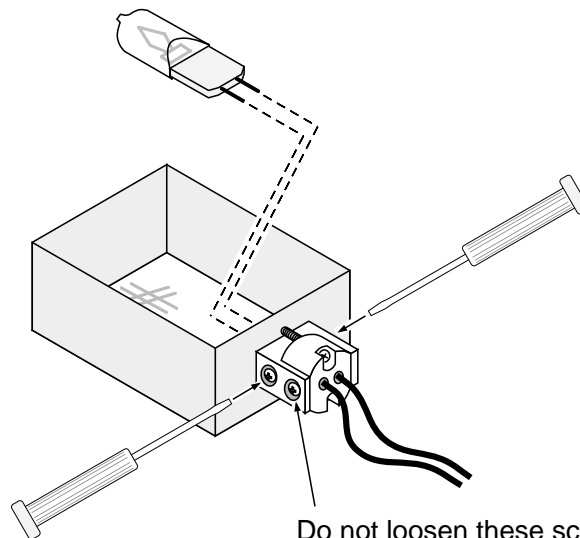

Micro (1/16") Standard  
or Philips Screwdriver

Do not loosen these screws  
(they hold the wires in place).



## Yearly Service Procedure

---

- Failure to inspect and maintain the heater may lead to improper combustion and a potentially dangerous situation. We recommend the following procedures be done by a qualified technician.
1. Turn the pilot flame to continuous. It should touch approximately 3/8" of the top of the flame sensor. If it does not, contact your dealer for service.
  2. Shut off gas to the heater and let it cool for 15 minutes. Remove the glass (see page 20). Glass may be cleaned with glass cleaner and a soft cloth (do not use abrasive cleaners).
  3. Remove the media (**NOTE: The media may be fragile**). If severely deteriorated, replace. Check the media for sooting. A small amount of soot along the bottom of the media is normal. If excessive sooting is found, the heater will require adjustment. Contact your dealer.
  4. Inspect the burner and remove any debris.
    - Make sure the burner is not warped, cracked, or damaged.
    - Check the firebox and area around the pilot to make sure there is no warping or damage.
    - If any problem is found, discontinue use and contact your dealer for service.
  5. Replace the media. Clean and replace the glass. If the glass is damaged, replace. Make sure the gasket along the perimeter of the glass contacts the face of the firebox and forms an air-tight seal. If it does not, re-align or replace the gasket to ensure an air-tight seal.
  6. Inspect the area behind the access door. Clean if necessary. Check the gas control valve and the gas lines. If damage is found, discontinue use and contact your dealer for service. Clean the air channels, ducts, and blower (if applicable).
  7. Start the main burner. Inspect the main burner and pilot flame. After 15 minutes the flames should be orange/yellow and not touch the top of the firebox. If the pilot or main burners do not burn correctly, contact your dealer for service. Monitor blower operation.
  8. Remove any debris or vegetation near the vent termination. Contact your dealer if any sooting or deterioration is found near the vent termination. Venting system should be examined by a qualified agency.

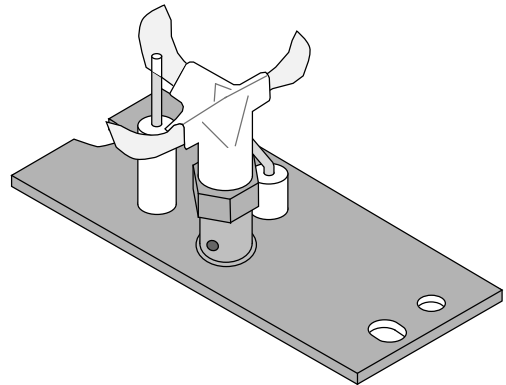

**Troubleshooting Table**

<b>Problem:</b>	<b>Possible Cause:</b>	<b>Don't Call for Service Until You:</b>
<b>Main Burners Will Not Start</b>	The battery box switch is turned to "OFF" ..... The remote control is not working correctly..... The thermostat is disconnected or set too low..... No propane in tank.....	Turn the battery box switch to "ON". See the remote control instructions. See "Thermostat Operation". Check Tank Level.
<b>Appliance Beeps</b>	<u>Heater beeps once:</u> The heater beeps once whenever a button on the remote is pressed..... <u>Heater beeps twice:</u> The heater beeps twice whenever a button on the remote is pressed.....	THIS IS NORMAL  The power backup batteries are low. Replace the 4 AA batteries in the battery box (see page 37).
<b>Thermostat Does Not Work</b>	The battery box switch is turned to "OFF" or "ON". The thermostat is set too low.....	Turn the battery box switch to "REMOTE". Check thermostat.
<b>Blower Does Not Work</b>	The fireplace is not getting electricity..... The fireplace is not up to temperature..... The blower fuse may be blown.....	Check the breaker switch. Let the fireplace burn for 10 minutes. Replace the fuse. See fuse location below.
<b>Fireplace Will Not Distribute Heat</b>	The fireplace is not getting electricity..... The fireplace is not up to temperature.....	Check the breaker switch. Let the fireplace burn for at least 15 minutes.
<b>Flames Are Too Blue</b>	The fireplace has just been started..... Improper air shutter adjustment.....	This is normal - see "Starting the Fireplace for the First Time". Adjust Air Shutter - contact your dealer.
<b>Rear Flames Are Too Short (Under 6")</b>	The flame height may be turned too low.....	Turn the flame height to "HI" - See "Adjusting the Flame Height".
<b>Thin Layer of Soot Covers the Glass</b>	The media or coals are placed incorrectly..... Improper air shutter adjustment.....	See "Media Installation". Adjust air shutter - contact your dealer.
<b>Accent Light Does Not Work</b>	The bulb may be burned out..... The accent light fuse may be blown. ....	See "Accent Light Replacement" on page 39. Replace the fuse. See fuse location below.

Location of fuses (3 amp) in lower right corner of firebox:

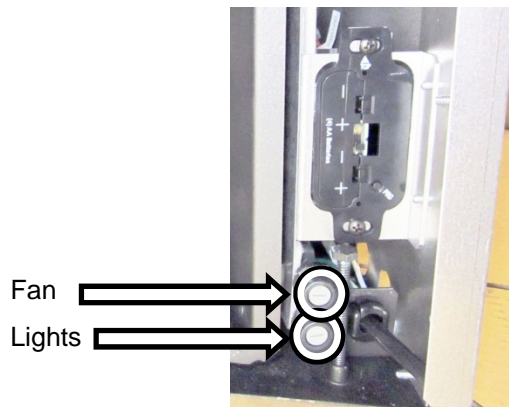

## Wiring Diagram

**CAUTION:** Label all wires prior to disconnection when servicing controls. Wiring errors can cause improper and dangerous operation.

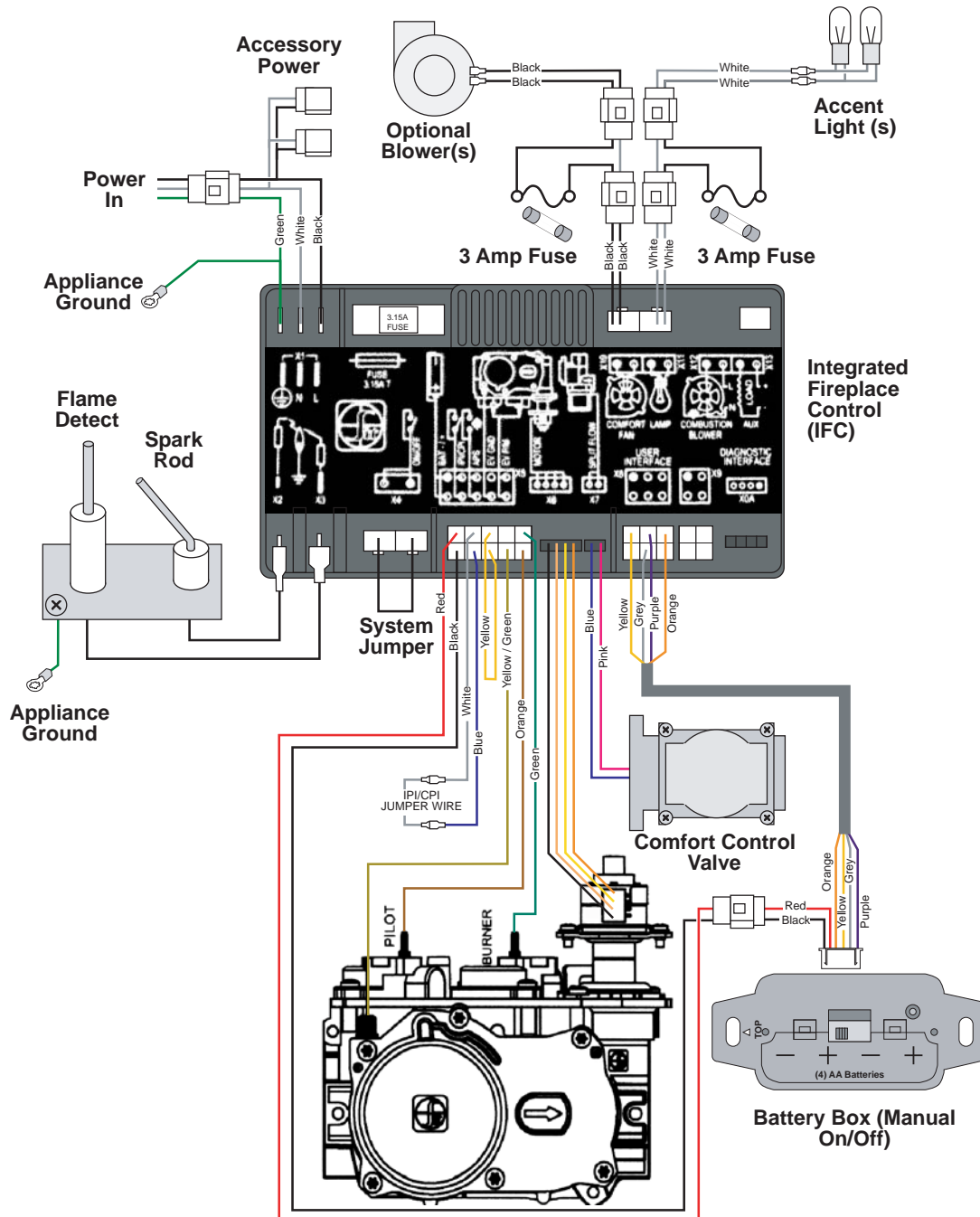

## Replacement Parts

**Caution:** Use only Travis Industries replacement parts. Do not use substitute materials.

**Warning:** Do not operate appliance with the glass front removed, cracked, or broken. Replacement of the glass should be done by a licensed or qualified service person.

Contact your local Travis Industries Dealer for a Replacement Parts List

Safety Label

The safety (listing) label is attached to the operating tag (chained to the heater near the gas control valve). A copy is shown below.

<p>Minimum Clearances to Combustibles</p>	
Side of Insert to Adjacent Wall	5" (127mm)
Hearth Depth	1.75" (45mm)
Hearth to Sides of Insert	0" (0mm)
Base of Insert to Mantel	See Owner's Manual
Base of Insert to Top Facing	See Owner's Manual
Flue Vent	See Owner's Manual
Enclosure Clearances	See Owner's Manual

<p>FAN TYPE VENTED CIRCULATOR</p> <p>Blower Electrical Rating: 120 VAC, 1.8 Amps, 60 Hz</p> <p>Part No. 228-10123 / 228-10124 fan or blower assembly may be used</p>		
Input Rate on "HR" (BTU/HR)	L.P. 31,000	M.G. 31,000
Input Rate on "LO" (BTU/HR)	7,702	11,241
Orifice Size - Front (DMS)	1.2mm	#48
Orifice Size - Rear (DMS)	1.2mm	#50
Minimum Inlet Pressure (inches W.C.)	L.P. 11"	M.G. 5.5"
Maximum Inlet Pressure (inches W.C.)	13"	7"
Manifold Pressure on "HR" (inches W.C.)	11"	3.5"

This appliance is equipped for use only at altitudes 0-2,000 feet (0-610m) in the USA. In Canada, 0-4,500 feet (0-1370m). For altitudes above 2,000 feet, the vent configuration, orifice, or combination of both may need to be changed. See owner's manual for information on making these changes.

**MANUFACTURE DATE:**

<input type="checkbox"/> 2014	<input type="checkbox"/> Jan.	<input type="checkbox"/> Apr.	<input type="checkbox"/> Jul.	<input type="checkbox"/> Oct.
<input type="checkbox"/> 2015	<input type="checkbox"/> Feb.	<input type="checkbox"/> May	<input type="checkbox"/> Aug.	<input type="checkbox"/> Nov.
<input type="checkbox"/> 2016	<input type="checkbox"/> Mar.	<input type="checkbox"/> Jun.	<input type="checkbox"/> Sep.	<input type="checkbox"/> Dec.

Manufactured by:



**TRAVIS INDUSTRIES**  
**APPLIANCE DIVISION**  
 12521 Highway 100, East Drive  
 Mukilteo, WA 98275  
 www.travisproducts.com

WARNING: Failure to install this appliance per the manufacturer's instructions or failure to use only parts specifically approved with this appliance may result in property damage or personal injury.

**VENTED GAS FIREPLACE HEATER - NOT FOR USE WITH SOLID FUEL**

**CAUTION:** Do not operate this appliance with glass removed, cracked or broken. Replacement of the panel(s) should be done by a licensed or qualified service person.

1053



Report No. G10518003RPT-001  
 Control No. 4000315

**430 GSR2**  
 Vented Gas Fireplace Heater

Tested to: ANSI Z21.88-2014/CSA 2.33-2014 "Vented Gas Fireplace Heater", CGA 2.17-M91 (R2009) "Gas Burning Heating Appliances for Manufactured Homes", and CSA P4.1-09 Testing method for measuring annual fireplace efficiency.

This appliance must be installed in accordance with local codes, if any; if none, follow the National Fuel Gas Code, ANSI Z223.1/NFPA 54, or Natural Gas and Propane Installation Codes, CSA B149.1.

This appliance must be installed in accordance with the current Standard CAN/CSA Z240 MH, Mobile Housing, in Canada or with the Manufactured Home Constructions and Safety Standard, Title 24 CFR, Part 3280, in the United States, or when such a standard is not applicable, ANSINC/SBCS A225.1/NFPA 501A, Manufactured Home Installation Standard.

This vented gas fireplace heater is equipped at the factory for use with natural gas. If conversion to propane (LP) is desired, the optional factory conversion kit must be used. Part No. 250-02863 register kit may be used.

This appliance is only for use with the type(s) of gas indicated on the rating plate and may be installed in an aftermarket, permanently located, manufactured home (USA only) or mobile home, where not prohibited by local codes. See owner's manual for details. This appliance is not convertible for use with other gases, unless a certified kit is used.

For OEM installation in a manufactured home (USA) only or mobile home only.

This vented gas fireplace heater is not for use with air filters.

Keep burner and control compartment clean. See installation and operating instructions accompanying appliance.

This appliance must be properly connected to a venting system in accordance with the manufacturer's installation instructions. Use only approved co-linear direct vent system to vent this appliance to the exterior. See owner's manual for approved brands of venting.

If the vent-air intake system is disconnected for servicing or any other reason, it must be resealed and / or reinstalled.

WARNING: Improper installation, adjustment, alteration, service or maintenance can cause injury or property damage. Refer to the owner's information manual provided with this appliance. For assistance or additional information consult a qualified installer, service agency or the gas supplier.

# Limited 7 Year Warranty

45

Register your TRAVIS INDUSTRIES, INC. Limited 7 Year Warranty online at [traviswarranty.com](http://traviswarranty.com), or complete the enclosed Warranty card and mail it within **ten (10)** days of the appliance purchase date to: TRAVIS INDUSTRIES, INC., 12521 Harbour Reach Drive, Mukilteo, WA 98275. TRAVIS INDUSTRIES, INC. warrants this gas appliance (appliance is defined as the equipment manufactured by Travis Industries, Inc.) to be defect-free in material and workmanship to the original purchaser from the date of purchase as follows:

**Check with your dealer in advance for any costs to you when arranging a warranty call.  
Mileage or service charges are not covered by this warranty. This charge can vary from store to store.**

Component	Years 1 & 2 Parts & Labor	Years 3 Through 5 Parts & Labor	Years 6 & 7 Parts Only
<b>Burner Assembly</b> Burner Pan Assembly, Air Shutter Assembly, Main Burner Orifice	✓		
<b>Electrical Assembly (within heater structure):</b> Wiring harness, snap discs, rheostat speed control, blowers, etc.	✓		
<b>Gas Control Assembly</b> Adjustable control valve, fireplace controller, pilot assembly and pilot wiring	✓		
<b>Glass</b> Glass (breakage from thermal shock)	✓		
<b>Media</b> Log Set, Stones, etc.	✓		
<b>Gold, Nickel &amp; Copper Plating</b> Face & Door (see "Conditions and Exclusions" # 9)	✓		
<b>Accessories</b> Firebacks, Power Heat Ducts, Andirons, etc...	✓		
<b>One-Way Freight Allowance</b> One-way freight allowance on pre-authorized repair done at factory is covered.	✓	✓	
<b>Convection Heat Exchanger</b> Convection heat exchanger assembly	✓	✓	
<b>Firebox Assembly</b> Adjustable Air Restrictor, Pressure Relief Mechanisms, Glass Attachment Mechanism	✓	✓	✓

### EXCLUDED COMPONENTS:

Paint, Gasketing, and Accent Light Bulbs

### CONDITIONS & EXCLUSIONS

- This new gas appliance must be installed by a qualified gas appliance technician. It must be installed, operated, and maintained at all times in accordance with the instructions in the Owner's Manual. Any alteration, willful abuse, accident, neglect, or misuse of the product shall nullify this warranty.
- This warranty is nontransferable, and is made to the ORIGINAL purchaser, provided that the purchase was made through an authorized TRAVIS dealer.
- Discoloration and some minor expansion, contraction, or movement of certain parts and resulting noise, is normal and not a defect and, therefore, not covered under warranty. The installer must ensure the appliance is burning as per the rating tag at the time of installation. Over-firing (operation above the listed BTU rate) of this appliance can cause serious damage and will nullify this warranty.
- The warranty, as outlined within this document, does not apply to the chimney components or other Non-Travis accessories used in conjunction with the installation of this product. If in doubt as to the extent of this warranty, contact your authorized TRAVIS retailer before installation.
- Travis Industries will not be responsible for inadequate performance caused by environmental conditions such as nearby trees, buildings, roof tops, wind, hills or mountains or negative pressure or other influences from mechanical systems such as furnaces, fans, clothes dryers, etc.
- This Warranty is void if:
  - The unit has been operated in atmospheres contaminated by chlorine, fluorine or other damaging chemicals.
  - The unit is subject to submersion in water or prolonged periods of dampness or condensation.
  - Any damage to the unit, combustion chamber, heat exchanger or other components due to water, or weather damage which is the result of, but not limited to, improper chimney/venting installation.
- Exclusions to this 7 Year Warranty include: injury, loss of use, damage, failure to function due to accident, negligence, misuse, improper installation, alteration or adjustment of the manufacturer's settings of components, lack of proper and regular maintenance, damage incurred while the appliance is in transit, alteration, or act of God.
- This 7 Year warranty excludes damage caused by normal wear and tear, such as paint discoloration or chipping, worn or torn gasketing, corroded or cracked logs, embers, etc. Also excluded is damage to the unit caused by abuse, improper installation, modification of the unit, drilling of the orifices, or the use of fuel other than that for which the unit is configured. Units are shipped for natural gas and must be converted to propane using the included conversion kit. Confirm fuel configuration with your installer.
- Damage to gold or nickel surfaces caused by fingerprints, scratches, melted items-, or other external sources left on the gold or nickel from the use of cleaners other than denatured alcohol is not covered in this warranty.
- TRAVIS INDUSTRIES, INC. is free of liability for any damages caused by the appliance, as well as inconvenience expenses and materials. Incidental or consequential damages are not covered by this warranty. In some states, the exclusion of incidental or consequential damage may not apply.
- This warranty does not cover any loss or damage incurred by the use or removal of any component or apparatus to or from the gas appliance without the express written permission of TRAVIS INDUSTRIES, INC. and bearing a TRAVIS INDUSTRIES, INC. label of approval.
- Any statement or representation of TRAVIS products and their performance contained in TRAVIS advertising, packaging literature, or printed material is not part of this 7 year warranty.
- This warranty is automatically voided if the appliance's serial number has been removed or altered in any way. If the appliance is used for commercial purposes, it is excluded from this warranty.
- No dealer, distributor, or similar person has the authority to represent or warrant TRAVIS products beyond the terms contained within this warranty. TRAVIS INDUSTRIES, INC. assumes no liability for such warranties or representations.
- Travis Industries will not cover the cost of the removal or re-installation of hearths, facing, mantels, venting or other components.
- If for any reason any section of this warranty is declared invalid, the balance of the warranty remains in effect and all other clauses shall remain in effect.
- THIS 7 YEAR WARRANTY IS THE ONLY WARRANTY SUPPLIED BY TRAVIS INDUSTRIES, INC., THE MANUFACTURER OF THE APPLIANCE. ALL OTHER WARRANTIES, WHETHER EXPRESS OR IMPLIED, ARE HEREBY EXPRESSLY DISCLAIMED AND PURCHASER'S RECOURSE IS EXPRESSLY LIMITED TO THE WARRANTIES SET FORTH HEREIN.**

### IF WARRANTY SERVICE IS NEEDED:

- If you discover a problem that you believe is covered by this warranty, you MUST REPORT it to your TRAVIS dealer WITHIN 30 DAYS, giving them proof of purchase, the purchase date, and the model name and serial number.
- Travis Industries has the option of either repairing or replacing the defective component.
- If your dealer is unable to repair your appliance's defect, he may process a warranty claim through TRAVIS INDUSTRIES, INC., including the name of the dealership where you purchased the appliance, a copy of your receipt showing the date of the appliance's purchase, and the serial number on your appliance. At that time, you may be asked to ship your appliance, freight charges prepaid, to TRAVIS INDUSTRIES, INC. TRAVIS INDUSTRIES, INC., at its option, will repair or replace, free of charge, your TRAVIS appliance if it is found to be defective in material or workmanship within the time frame stated within this 7 year warranty. TRAVIS INDUSTRIES, INC. will return your appliance, freight charges (years 1 to 5) prepaid by TRAVIS INDUSTRIES, INC., to your regional distributor, or dealership.
- Check with your dealer in advance for any costs to you when arranging a warranty call. Mileage or service charges are not covered by this warranty. This charge can vary from store to store.

**LP Conversion Instructions****WARNING**

This conversion kit shall be installed by a qualified service agency in accordance with the manufacturer's instructions and all applicable codes and requirements of the authority having jurisdiction. If the information in these instructions is not followed exactly, a fire, explosion or production of carbon monoxide may result causing property damage, personal injury or loss of life. The qualified service agency is responsible for the proper installation of this kit. The installation is not proper and complete until the operation of the converted appliance is checked as specified in the manufacturer's instructions supplied with the kit.

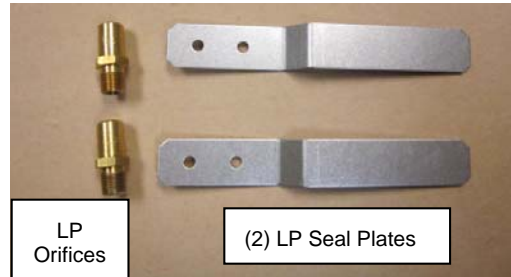
**Packing List**

**Convert the appliance prior to installing the gas line to ensure proper gas use.**

The GSR Stepper Motor Kit (SKU 94400999) is required for converting this appliance to LP. The kit contains the stepper motor (regulator), torx wrench, and pilot orifice. The burner orifices and burner gaskets are shipped with the appliance.

1. Access the firebox.
2. Remove the burners (see "Burner Removal").
3. When using LP, remove and discard the two existing orifice gaskets (see below).

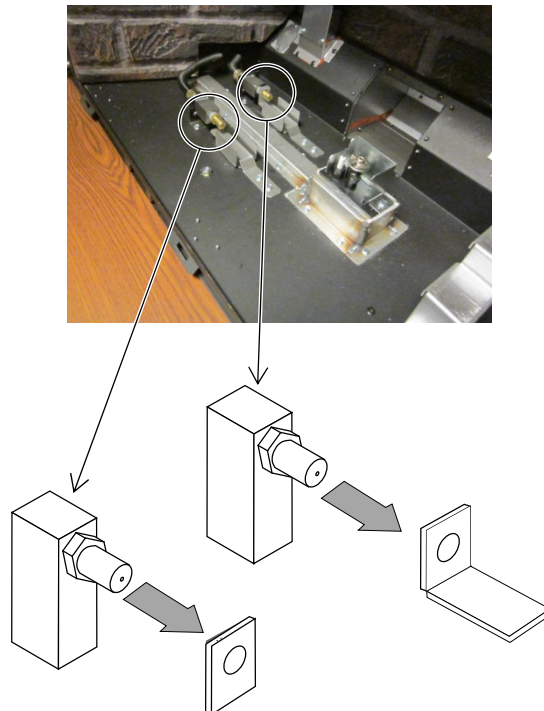



4. Remove and discard the stock seal plates. Install the LP seal plates as shown below.

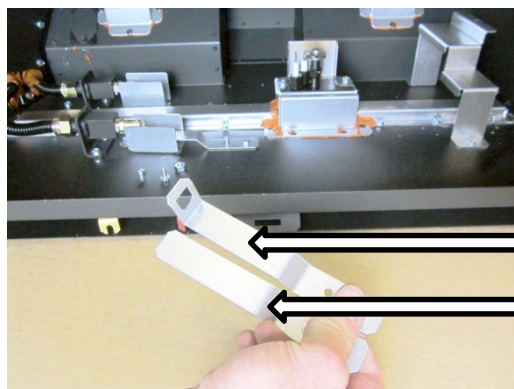
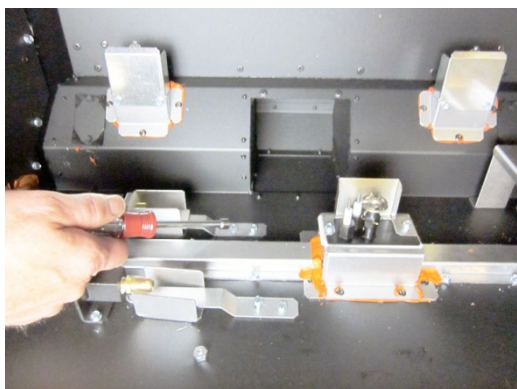
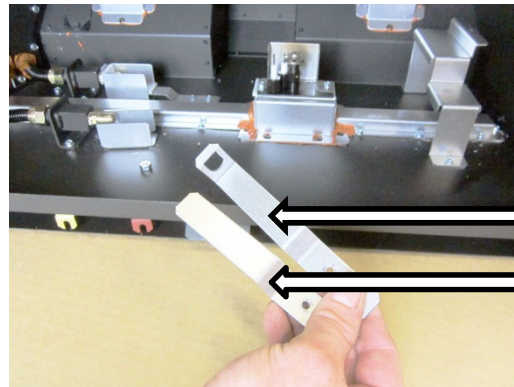
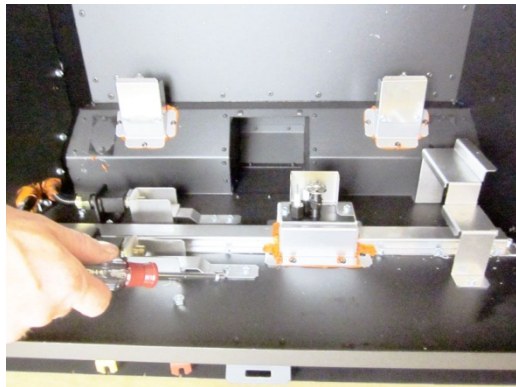

5. Install the LP (propane) orifices.

Screw each LP orifice in so the orifice protrudes 15/16" (24mm) (indicating full insertion).

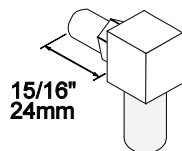

Apply thread sealant to the LP orifices prior to installation. Use the chart below to identify the correct orifices.

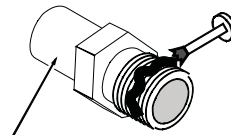

Look here for the orifice identification

<b>ORIFICE SIZE (ID)</b>	Natural Gas	LP (Propane)
Front Burner Orifice	#48 DMS	1.2mm DMS
Rear Burner Orifice	#50 DMS	1.2mm DMS

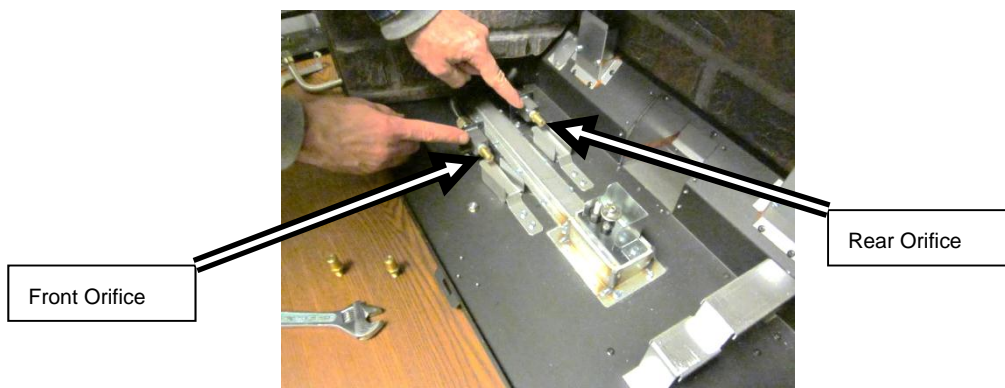

6. Install the LP pilot orifice following the directions below.
  - (a) Use a 7/16" open-end wrench to remove the pilot hood.
  - (b) Remove and discard the Natural Gas (NG) orifice. Place the LP orifice in the pilot assembly then replace the pilot hood, tightening the pilot hood until it is snug (do not over-tighten).

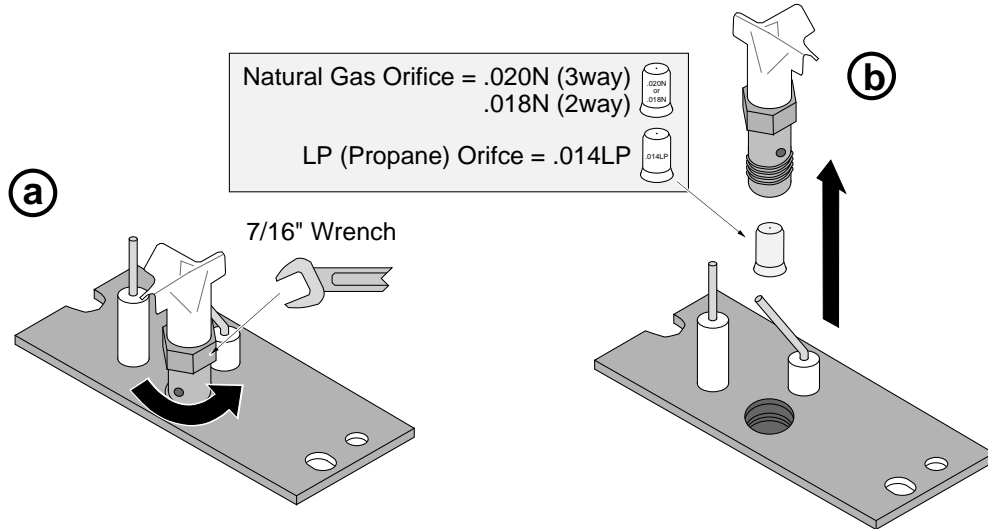

7. Replace the firebox components. Restore the fireplace to the correct configuration. Install the firebacks before re-installing the burner.
8. Access the stepper motor (shown below). The stepper motor (adjustable regulator) has an installation sheet included with it – make sure to follow all of the directions. Disconnect the wiring from the stepper motor. Remove the stock stepper motor and replace with the LP version. – **MAKE SURE IT IS CORRECTLY ORIENTED.** Secure using the screws included with the motor – tighten to 25 Lb-inches. Leak test this area after installation to verify proper installation. Re-attach the wiring.



9. Restore the appliance to the correct configuration. Make the gas line connection, bleed the gas line (if applicable), start the heater and thoroughly leak-test all gas connections and the gas control valve.





Accent Light Replacement .....	39	Installation Warnings .....	7
Additional Items Required .....	7	Introduction .....	2
Battery Replacement.....	37	Leveling Bolts.....	10
Before You Begin .....	29	Listing Details.....	2
<b>Child-Proof Feature</b> .....	38	Location of Controls.....	31
Clearances .....	11	<b>Low Battery Indicator</b> .....	37
Continuous/Intermittent Pilot Switch .....	32	LP Conversion Instructions.....	46
Diffuser Adjustment.....	17	Maintaining Your Heater's Appearance .....	39
Dimensions .....	6	Normal Operating Odors.....	38
Direct Operation .....	31	Normal Operating Sounds .....	38
Display Fahrenheit or Celsius .....	36	Order of Installation.....	7
Electrical Requirements .....	10	Packing List.....	7
Electrical Specifications (for blowers) .....	6	<b>Power Outages</b> .....	37
Exhaust Restrictor .....	15	Remote Control Warnings .....	29
Features .....	6	Remote Operation.....	33
Fireplace Requirements .....	8	<b>Remote Set-Up</b> .....	30
Fuel .....	6	Replacement Parts .....	43
Gas Line Installation.....	13	<b>Starting the Heater for the First Time</b> .....	31
Gas Line Requirements .....	12	Steps for Finalizing the Installation .....	24
Glass Frame Removal and Installation .....	23	Troubleshooting Table .....	42
Hearth Requirements .....	9	Vent Installation .....	18
Heating Specifications.....	6	Vent Requirements .....	14
Important Information.....	2	Wiring Diagram .....	43
Installation Options.....	6	Yearly Service Procedure .....	41